



# High performance exhaust systems





*As always we are pleased to present you with the new edition of our catalogue covering the whole range of our products. We have expanded our offer introducing many brand new releases in each assortment group. We bring to you new dedicated mufflers, modifications to tail pipes' line and car exhaust embellishers created for specific car models in response to the ever-changing trends in pattern-designing and market requirements.*

*Thanks to the development of the production process technology and further improvement of the quality management system, our production plant has been awarded the certificate of conformity, meeting the requirements of the most demanding motor vehicle standard – ISO TS 16949:2009.*

*We have fully committed ourselves to the implementation of the above standard in order to respond to the dynamically changing market. Our ultimate goal is to satisfy your demands supplying you with product which adhere to the strictest quality norms. Here is your chance to design and build your own custom car. Will you take advantage?*



# TAIL PIPES OFFER

## Tail pipes - single and double

They are assembled by screwing with a clamping ring or welding on. They have a so-called assembly cup, which is adjusted appropriately to the diameter of the exhaust pipe.

Most frequently offered diameters:

Ø42 Ø45 Ø50 Ø55 Ø60

– depending on the technical capabilities.

Dimensions quoted in the offer specify the following:

For *single tail pipes* – shape and length of the assembly element

For *double tail pipes* – shape and length of the decorative element, without an assembly cup.

\* (asterisk) indicates a tail pipe without perforated insert (diffuser)

## Mounting pipes

They are assembled directly to the end-cover of the silencer, by welding them on.

Mounting pipes are marked with **orange** colour.

## Tail pipes and embellishers for specific car models

They are assembled on the exhaust pipe of the silencer with a fixing screw or a clamping ring.

Dedicated embellishers are adjusted to specific car models. They give them an original look and ensure trouble-free assembly.

# SINGLE TAIL PIPES ● MOUNTING PIPES

round

ø60

**N1-03\*** (Ø60x90)

**N1-05\*** (Ø60x140)

**N1-53** (Ø60x110)

ø70

**N1-71** (Ø70x120)



**N1-70RS** (Ø70x120)  
**N70RS** (Ø70x200)



ø80

**N1-07** (Ø80x120)  
**N1-07D** (Ø80x200)  
**N1-07K** (Ø80x80)  
**N07** (Ø80x200)



**N1-07-1** (Ø80x120)  
**N1-07-1D** (Ø80x200)  
**N1-07-1K** (Ø80x80)  
**N07-1** (Ø80x200)



**N1-07-2** (Ø80x120)  
**N1-07-2D** (Ø80x200)  
**N1-07-2K** (Ø80x80)  
**N07-2** (Ø80x200)



**N1-13DTM** (Ø80x170)  
**N13DTM** (Ø80x250)



**N1-13-1** (Ø80x170)  
**N13-1** (Ø80x250)



**N1-29** (Ø80x120, inlet Ø50)  
**N1-29D** (Ø80x200, inlet Ø50)  
**N1-32** (Ø80x120, inlet Ø60)  
**N1-32D** (Ø80x200, inlet Ø60)



**N1-61** (Ø80x120)



ø90

**N1-90RS** (Ø90x120)  
**N90RS** (Ø90x200)



**N1-91** (Ø90x120)



ø100

**N1-16** (Ø100x120)  
**N16** (Ø100x165)



**N1-16-1** (Ø100x120)  
**N16-1** (Ø100x200)



# SINGLE TAIL PIPES — MOUNTING PIPES

round



Ø100

**N1-17-1** (Ø100x120)  
**N17-1** (Ø100x200)

**N1-17-2** (Ø100x120)  
**N17-2** (Ø100x200)

**N1-19-2** (Ø100x170)  
**N19-2** (Ø100x250)

**N1-22** (Ø100x120)  
**N22** (Ø100x200)



**N1-60** (Ø100x150)

**N1-101RS** (Ø100x120)  
**N101RS** (Ø100x200)

oval



65x55

**N1-15K** (65x55x80)

110x45

**N1-34** (110x45x80)

**N1-34-1** (110x45x80)

95x65

**N1-09** (95x65x120)



**N1-10** (95x65x120)  
**N1-10D** (95x65x200)  
**N1-10K** (95x65x80)  
**N10** (95x65x200)

**N1-10-1** (95x65x120)  
**N1-10-1D** (95x65x200)  
**N10-1** (95x65x200)

**N1-57 L\*** (95x65x120)  
**N1-57 R\***

**N1-14-1** (95x65x170)  
**N14-1** (95x65x250)

# SINGLE TAIL PIPES ● MOUNTING PIPES

oval



120x80

**N1-26** (120x80x120)  
**N26** (120x80x200)



**N1-27 L** (120x80x120)  
**N1-27 R**  
**N27 L** (120x80x200)  
**N27 R**



**N1-28** (120x80x120)  
**N28** (120x80x200)



145x75

**N1-21-1** (145x75x140)  
**N1-21-1D** (145x75x200)  
**N21-1** (145x75x240)



145x75

**N1-21-1 L** (145x75x140)  
**N1-21-1 R**  
**N21-1 L** (145x75x240)  
**N21-1 R**



**N1-21-1DTM** (145x75x200)  
**N21-1DTM** (145x45x300)

167x75

**N1-50** (167x60x120)  
**N1-50D** (167x60x200)  
**N50** (167x60x200)



**N1-50\*** (167x60x120)  
**N1-50D\*** (167x60x200)  
**N50\*** (167x60x200)



82x54

**N1-44\*** (82x54x120)



80x65

**N1-12-1** (80x65x120)  
**N12-1** (80x65x200)

rectangular



100x75

**N1-24** (100x75x120)  
**N24** (100x75x200)



**N1-24-1** (100x75x120)



105x80

**N1-33D L** (105x80x200)  
**N1-33D R**  
**N33 L** (105x80x200)  
**N33 R**



130x65

**N1-47\*** (130x65x120)



# SINGLE/DOUBLE TAIL PIPES ● MOUNTING PIPES

## special



**N1-46L\*** (110x65x120)  
**N1-46R\***

**N1-48L\*** (160x80x120)  
**N1-48R\***  
**N48L\*** (160x80x200)  
**N48R\***

**N1-49L\*** (160x80x120)  
**N1-49R\***  
**N49L\*** (160x80x200)  
**N49R\***

**N1-52\*** (125x95x120)  
**N1-52D\*** (125x95x200)  
**N52\*** (125x95x200)



**N1-30 L** (170x55x120)  
**N1-30 R**  
**N30 L** (170x55x200)  
**N30 R**

**N1-30L\*** (170x55x120)  
**N1-30R\***

**N1-36 L** (170x70x120)  
**N1-36 R**



## round



**Ø60**

**N2-03\*** (Ø60x170)

**N2-05\*** (Ø60x220)

**N2-53** (Ø60x175)

**Ø70**

**N2-70RS** (Ø70x200)

**N1-45L\*** (86x54x120)  
**N1-45R\***

**N1-58L\*** (86x54x120)  
**N1-58R\***



# DOUBLE TAIL PIPES

round

ø70



N2-70RSL (Ø70x200/180)  
N2-70RSR

ø80



N2-07-1 L (Ø80x200/180)  
N2-07-1 R



N2-07K (Ø80x160)  
N2-07 (Ø80x200)

N2-07-1K (Ø80x160)  
N2-07-1 (Ø80x200)  
N2-07-1\* (Ø80x200)

N2-07-2K (Ø80x160)  
N2-07-2 (Ø80x200)

N2-13DTM (Ø80x260)



N2-13-1 (Ø80x260)

N2-61 (Ø80x200)

ø90

N2-90RSL (Ø90x225/205)  
N2-90RSR



ø100

N2-90RS (Ø90x225)

N2-101RSL (Ø100x225/205)  
N2-101RSR

N2-101RS (Ø100x225)



# DOUBLE TAIL PIPES

round



Ø100

N2-17-1 (Ø100x230)

N2-43L\* (Ø100x160x220)  
N2-43R\*

oval



65x55

N2-15K (65x55x160)



95x65

N2-10K (95x65x160)  
N2-10 (95x65x200)



N2-10-1L (95x65x200/180)  
N2-10-1R



95x65

N2-10-1 (95x65x200)  
N2-10-1\* (95x65x200)



N2-57\* (95x65x200)



N2-57L\* (95x65x200)  
N2-57R\*



N2-56L\* (160x65x200)  
N2-56R\*



120x80

N2-26 (120x80x250)



N2-27 (120x80x250)

# DOUBLE TAIL PIPES

oval



**N2-27L** (120x80x250)  
**N2-27R**



**N2-28** (120x80x250)



**N2-54L\*** (220x80x220)  
**N2-54R\*** (220x80x220)



**N2-55L\*** (220x80x220)  
**N2-55R\*** (220x80x220)

special

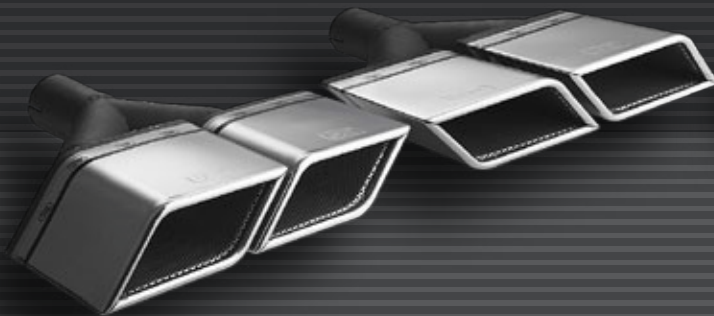

**N2-36L** (170x70x220)  
**N2-36R**



**N2-45L\*** (86/82x54x200)  
**N2-45R\*** (82/86x54x200)



**N2-45\*** (86x54x200)



**N2-58\*** (86x54x200)



**N2-46\*** (110x65x200)



**N2-52\*** (125x95x200)



# DOUBLE TAIL PIPES / OTHER

## rectangular



80x65

N2-12-1 (80x65x200)



82x54

N2-44\* (82x54x200)



100x75

N2-24 (100x75x270)



N2-24-1 (100x75x270)

## with two inlets



N3-21-1\* (145x75x140)



N3-21-1 L\* (145x75x140)  
N3-21-1 R\*



N3-50 (167x60x120)

# SINGLE/DOUBLE TAIL PIPES

## BLACKLINE

Ø70



**NBL1-70RS\*** (Ø70x120)



**NBL2-70RS\*** (Ø70x200)



**NBL2-70RSL\*** (Ø70x200/180)  
**NBL2-70RSR\***

Ø90



**NBL1-90RS\*** (Ø90x120)



**NBL2-90RS\*** (Ø90x200)



**NBL2-90RSL\*** (Ø90x200/180)  
**NBL2-90RSR\***



# EXHAUST EMBELLISHERS

universal



**NX01** (Ø60x150) Ø30-Ø50  
**NX100** (Ø50x100) Ø30-Ø40



**NX04** (Ø60x150) Ø30-Ø50



**NX07** (Ø80x150) Ø38-Ø48  
**NX07.1** (Ø80x150) Ø45-Ø56  
**NX07.2** (Ø80x200) Ø48-Ø56  
**NX07.3** (Ø80x200) Ø60-Ø70



**NX70** (Ø70x120) Ø40-Ø60  
**NX70D** (Ø70x200) Ø40-Ø60  
**NX90** (Ø90x120) Ø65-Ø80  
**NX90D** (Ø90x200) Ø65-Ø80



**NX10** (95x65x120) Ø40-Ø55  
**NX26** (120x80x120) Ø50-Ø70



**NX10-1** (95x65x120) Ø40-Ø55  
**NX28** (120x80x120) Ø50-Ø70



**NFC** (95x65x120) Ø30-Ø42



**NX12-1** (80x65x120) Ø40-Ø55



**NX33 L** (105x80x200) Ø50-Ø60  
**NX33 P** (105x80x200) Ø50-Ø60



**NX050** (Ø50)  
**NX060** (Ø60)

# EXHAUST EMBELLISHERS DEDICATED TO SPECIFIC CAR MODELS

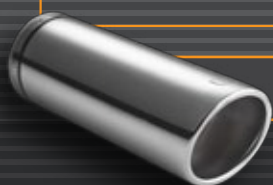

**round Ø70**

- NX70.9** FIAT BRAVO II 1,9JTD
- NX70.1** FORD FOCUS II HB
- NX70.5** SKODA OCTAVIA II 1,9TDi (2 pcs. in the set)
- NX70.6** SKODA ROOMSTER 1,9TDi (2 pcs. in the set)
- NX70.7** SKODA ROOMSTER 1,4TDi (2 pcs. in the set)
- NX70.8** SKODA YETI 1,9TDi (2 pcs. in the set)
- NX70.2** TOYOTA AYGO
- NX70.3** TOYOTA YARIS II 1,3i



**oval 95x65**

- NX10.28** FORD FOCUS II SEDAN 1,6 Ti-VCT
- NX10.4** NISSAN ALMERA HB 1,5i 00->
- NX10.9** NISSAN MICRA K12
- NX10.17** NISSAN NOTE E11
- NX10.5** SUZUKI IGNIS
- NX10.54** SUZUKI SPLASH
- NX10.14** SUZUKI SWIFT 05->
- NX10.2** TOYOTA COROLLA HB 01->04
- YARIS N10** TOYOTA YARIS I
- NX10.15** TOYOTA YARIS II 1,0



**round Ø80**

- NX07.9** CITROEN C3 1,1
- NX07.19** DACIA LOGAN
- NX07.6** FIAT PANDA 1,1; 1,2
- NX07 FH/1,4** FORD FOCUS I HB 1,4;1,6
- NX07 FH/2,0** FORD FOCUS I HB 1,8;2,0
- NX07.2 FS/1,4** FORD FOCUS I SEDAN 1,4;1,6
- NX07.2 FS/2,0** FORD FOCUS I SEDAN 1,8;2,0
- NX07.4 FC/1,4** FORD FOCUS I COMBI 1,4;1,6
- NX07.4 FC/2,0** FORD FOCUS I COMBI 1,8;2,0
- NX07.17** FORD KA I 1,3
- NX07.23** MAZDA 5
- NX07.7** NISSAN ALMERA SEDAN 1,5dCi 02/00->
- NX07.14** NISSAN ALMERA SEDAN 1,5i 02/00->
- NX07.20** OPEL ZAFIRA 1,8
- NX07.12** PEUGEOT 1007 1,4
- NX07.11** SUZUKI GRAND VITARA 3D 1,6 05->
- NX07.5** SUZUKI GRAND VITARA 5D 2,0 05->
- NX07.25** SUZUKI GRAND VITARA 5D 2,4 07->
- NX07.16** SUZUKI JIMNY
- NX07.15** SUZUKI LIANA HATCHBACK
- NX07.13** SUZUKI LIANA SEDAN
- NX07.24** SUZUKI SPLASH
- NX07.10** SUZUKI SWIFT 05->
- NX07.18** SUZUKI SX4
- NX07.8** TOYOTA RAV 4 00-05



**oval 95x65**

- NX10.43** CHEVROLET LACETTI HB
- NX10.22** FIAT GRANDE PUNTO 1,2; 1,4 8V
- NX10.57** FIAT PUNTO EVO 1,4i
- NX10.25** FORD FIESTA 1,25; 1,3 05->
- NX10.26** FORD FOCUS II COMBI 1,6 Ti-VCT
- NX10.11FH** FORD FOCUS II HB 1,4;1,6
- NX10.27** FORD FOCUS II HB 1,6
- NX10.23** FORD FOCUS II HB 1,8TDCi
- NX10.29** FORD FUSION 1,4i 05->
- NX10.30** FORD FUSION TDCi 05->
- NX10.3** FORD FUSION 1,25; 1,3; 1,4
- NX10.3D** FORD FUSION 1,4TDCi; 1,6
- NX10.24** FORD GALAXY 2,0TDCi 06->
- NX10.1** FORD MONDEO TDCi SEDAN, HATCHBACK 00->
- NX10.1.2** FORD MONDEO TDCi COMBI 00->
- NX10.48** FORD MONDEO COMBI HB 1,6i; 2,0i; 2,5i 07->
- NX10.53** FORD MONDEO HB COMBI 1,8TDCi; 2,0TDCi 07->
- NX10.50** FORD MONDEO SEDAN 1,8TDCi; 2,0TDCi 07->
- NX10.47** KIA CEE'D COMBI
- NX10.46** KIA CEE'D HB
- NX10.16** KIA CERATO HB 1,6
- NX10.31** KIA MAGENTIS 2,0 CRDi
- NX10.13** KIA PICANTO
- NX10.20** KIA RIO II HB 1,5CRDi
- NX10.21** KIA RIO II SEDAN 1,5CRDi
- NX10.42** OPEL ASTRA H GTC 1,4
- NX10.36** OPEL CORSA D 1,0
- NX10.32** OPEL CORSA D 1,2; 1,4
- NX10.41** OPEL VECTRA C 1,8 SEDAN
- NX10.8** PEUGEOT 206 HB
- NX10.33** PEUGEOT 207 1,4
- NX10.34** PEUGEOT 307 1,4 06->
- NX10.35** PEUGEOT 407 1,8i
- NX10.19** SEAT IBIZA 1,4 02->
- FABIA N10** SKODA FABIA I
- NX10.56** SKODA FABIA II HB 1,2i
- NX10.39** TOYOTA AURIS 1,4 D4D
- NX10.38** TOYOTA AURIS 1,6
- NX10.12** TOYOTA AYGO 1,0
- NX10.40** TOYOTA COROLLA 06->
- NX10.6** TOYOTA COROLLA HB 04->
- NX10.7** TOYOTA COROLLA WAGON 04->
- NX10.37** TOYOTA YARIS II 1,3
- NX10.59** TOYOTA YARIS III
- NX10.18** VW POLO HB 1,2; 1,4 01->05



**oval 120x80**

- NX26.13** CHEVROLET CRUZE SDN, HB 5D 2,0 VCDI 09->12
- NX26.1** FORD MONDEO SEDAN, HATCHBACK BENZ 01->
- NX26.14** FORD MONDEO MK IV CBI, SDN, HB 2,0 TDCi 07->12
- NX26.10** FORD GALAXY 2,0 TDCi 06->
- NX26.8** KIA CARNIVAL 2,9 CRDi 06->
- NX26.5** NISSAN PRIMERA HB 02->
- NX26.9** PEUGEOT 407 SW HDI
- NX26.3D** TOYOTA AVENSIS COMBI 2,2D 02->
- NX26.3** TOYOTA AVENSIS COMBI BENZ 02->
- NX26.2D** TOYOTA AVENSIS SDN/LIFTB 2,2D 0,2->
- NX26.2** TOYOTA AVENSIS SDN/LIFTB BENZ 02->
- NX26.11** TOYOTA AVENSIS SEDAN 2,2 D4D
- NX26.4** TOYOTA COROLLA HB 04->
- NX26.6** TOYOTA COROLLA WAGON 04->
- NX26.7** TOYOTA COROLLA VERSO



# LEGEND CONSTRUCTION

## EXPLANATIONS TO THE OFFER OF SPORT MUFFLERS

### 101-101/07-2

Number representing make of the car (Audi)

### 101-101/07-2

Number representing model of the car (Audi A3)

### 101-101/07-2

Designation of muffler with single tail pipe

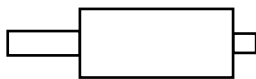

### 101-201/07-2

Designation of muffler with double tail pipe

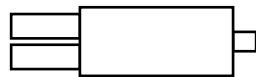

### 101-301/07-2

Designation of muffler with two single tail pipes (i.e. 1 at the left side and 1 at the right side of the car)

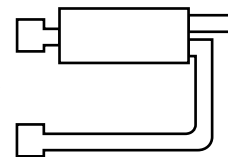

### 101-401/07-2

Designation of muffler with two double tail pipes (i.e. 2 at the left side and 2 at the right side of the car)

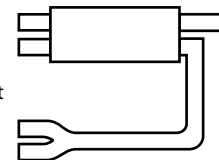

### 101-101/07-2

Number representing the type of tail pipe (N07-2)

## CONSTRUCTION

Products of Ulter-Sport have homologation certificates confirmed by TÜV SÜD Munich, which cooperates with us in relation to the compliance of our products with the respective regulations of the European Union.

● **Separating walls** made of stainless or aluminium plated steel are personalized for exact car characteristics. The absorption and reflective chambers have dimensions which guarantee the optimum amounts of counterpressures at the maximum reduction of the level of emitted noise.

● **Sound absorbing material** with the adequate specification of the frequency of the physical sound absorbing factor. The material has a high technical and mechanical strength.

● **Tail pipe** made of stainless steel, appropriately fitted to the silencer in respect to the acoustics, which guarantees the minimum flow resistance at the same time.

● Appropriately profiled **inlet pipe**.

● **Silencer body** closing the silencer's chambers, which is required for the correct occurrence of the wave effect and increasing the effectiveness of sound absorbing material and, which concurrently guarantees trouble-free operation for many years, thanks to the application of aluminium plated steel or stainless steel.

● **Perforated pipes** applied to avoid the direct transfer of the front acoustic wave, which considerably reduce the distribution of noise and improve the wave processes in the expansion chamber.

Appropriately selected perforation is a guarantee of the effective silencing of the middle and top bands by sound-absorbing material in the thoroughfare chamber. The surface of the perforation is adjusted to the type of engine and its cubic capacity and the dimensions of the intake system. It allows the free flow of exhaust gases, which is required to ensure optimum engine performance within whole rotation range.



## ALFA ROMEO 145

97 -> 01

1,4 i.e. 76kW  
1,6 i.e. 88kW  
1,8 i.e. 103kW  
2,0 i 110kW



Muffler with  
**single**  
tail pipe  
100-110/10  
100-110/21-1

## ALFA ROMEO 147 GTA

03 -> 10

3,2 V6 184kW



Muffler with  
**double**  
tail pipe  
100-209/70RS

## ALFA ROMEO 147

00 -> 09

1,6 77/88kW  
2,0 110kW



Muffler with  
**single**  
tail pipe  
100-101/12-1  
100-101/26\*

\* facelifted version requires bumper trimming

## ALFA ROMEO 156

sedan, sportwagon

10/97 -> 07

1,6 88kW  
1,8 106kW  
2,0 114kW



Muffler with  
**single**  
tail pipe  
100-102/21-1  
100-102/26

## ALFA ROMEO 147

00 -> 09

1,9 JTD 74/85/88/103/110kW



Muffler with  
**single**  
tail pipe  
100-108/12-1  
100-108/26\*

\* facelifted version requires bumper trimming

## ALFA ROMEO 156

sedan, sportwagon

10/97 -> 07

1,9 JTD 77/81/85kW  
1,9 JTD 93/103/110kW  
2,4 JTD 100/103/110kW  
2,4 JTD 129kW  
2,5 V6 140/141kW



Muffler with  
**single**  
tail pipe  
100-104/21-1  
100-104/26

## ALFA ROMEO 159

sedan, sportwagon

05 -> 11

1,9 JTS 118kW  
1,9 JTDM 88/110kW



Muffler with  
**single**  
tail pipe

100-105/90RS

Two mufflers  
with two single  
tail pipes L+R

100-305/90RS

## ALFA ROMEO MiTo

08 ->

1,4i 16V 57/64/77kW  
1,4T 99/114kW  
1,3 JTDM 70kW  
1,6 JTD 88kW



Muffler with  
**single**  
tail pipe

100-106/10  
100-106/28

Muffler with  
**double**  
tail pipe

100-206/53  
100-206/70RS

## ALFA ROMEO 159

sedan, sportwagon

05 -> 11

2,4 JTD 147kW



Set of two mufflers L+R

100-311/90RS

## ALFA ROMEO GT

04 -> 10

1,8 TS 103kW  
2,0 JTS 121kW  
1,9 JTD 110kW



Muffler with  
**single**  
tail pipe

100-103/21-1

Muffler with  
**double**  
tail pipe

100-203/70RS

## ALFA ROMEO Giulietta

10 ->

1,4 T 16V 77/88/125kW\* (single and duplex version)

Muffler with **single** tail pipe

100-113/101RS



Muffler with **two single** tail pipes L+R

100-313/101RS



1,75 T 16V 172kW\*\* (duplex muffler only)

2,0 JTD 125kW\*\* (duplex muffler only)

Muffler with **two single** tail pipes L+R

100-312/101RS

\* with one original cutout in bumper

\*\* with two original cutouts in bumper

## AUDI A3 type 8P

*hatchback*

**03 -> 12**

1,4 TFSI 90kW  
 1,6\* 75/85kW  
 2,0 FSi 110kW  
 1,6 TDi 66/77kW  
 1,9 TDi 77kW  
 2,0 TDi 100/103/125kW



**Muffler with single tail pipe**

101-103/27

**Muffler with double tail pipe**

101-203/70RS



**DUPLEX version \***

**Muffler with two single tail pipes L+R**

101-303/27

**Muffler with two double tail pipes L+R**

101-403/70RS

\* cutout in bumper necessary

## AUDI A3 type 8P SPORTBACK

**04 -> 12**

1,6 75/85kW  
 2,0 FSi 110kW  
 1,6 TDi 66/77kW  
 1,9 TDi 77kW  
 2,0 TDi 100/103/125kW



**Muffler with single tail pipe**

101-105/27

**Muffler with double tail pipe**

101-205/70RS

## AUDI A3 type 8P SPORTBACK



**DUPLEX version \***

**Muffler with two single tail pipes L+R**

101-305/27

**Muffler with two double tail pipes L+R**

101-405/70RS

\* cutout in bumper necessary

## AUDI A3 type 8L

*hatchback*

**09/96 -> 05/03**

1,9 TDi 66/74/81/96kW  
 1,8 T 110/132kW  
 1,8 92kW  
 1,6 74/75kW



**Muffler with single tail pipe**

101-101/21-1  
 101-101/28

**Muffler with double tail pipe**

101-201/07-2  
 101-201/70RS



**Muffler with two single tail pipes L+R**

101-301/21-1

**Muffler with two double tail pipes L+R**

101-401/07-2

## AUDI A4 type B5

sedan, avant

11/94 -> 09/01

1,8T 110kW  
1,9TDI 66/81/85kW  
1,6 74kW  
1,8 92kW



Muffler with **double** tail pipe

101-202/07-2  
101-202/70RS

Muffler with **single** tail pipe

101-102/21-1  
101-102/28

## AUDI A4 type 8E,8F/B7

sedan, avant

...continued



**DUPLEX version \***

Two mufflers with **two single** tail pipes L+R

101-309/27  
101-309/21-1

Two mufflers with **two double** tail pipes L+R

101-409/70RS

\* cutout in bumper necessary  
only for the factory exhaust system with one rear muffler

## AUDI A4 type B5

sedan, avant

97 -> 01

2,6 V6 110kW  
2,8 V6 128kW  
2,5 TDi V6 110kW



Muffler with **double** tail pipe

101-204/07-2  
101-204/70RS

Muffler with **single** tail pipe

101-104/21-1  
101-104/28

## AUDI A4 type 8K

sedan, avant

08 ->

1,8 TFSi 88/118kW  
1,9 TDI 85kW  
2,0 TDI 100/105/125kW



Muffler with **single** tail pipe

101-106/21-1  
101-106/27

Muffler with **double** tail pipe

101-206/70RS

## AUDI A4 type 8E,8F/B7

sedan, avant

05 ->08

1,6 75kW  
1,8 T 120kW  
2,0 96kW  
1,9 TDI 85kW  
2,0 TDI 103kW



Muffler with **single** tail pipe

101-109/21-1  
101-109/27

Muffler with **double** tail pipe

101-209/70RS

**DUPLEX version \***

Two mufflers with **two single** tail pipes L+R

101-306/27  
101-306/21-1

Two mufflers with **two double** tail pipes L+R

101-406/70RS

\* cutout in bumper necessary  
only for the factory exhaust system with one rear muffler

## AUDI A5

coupe

08 -> 11

2,0 TDi 125kW



Muffler with **two double tail pipes L+R**

101-414/70RS

cutout in bumper necessary

## AUDI TT type 8N

coupe, cabrio

98 -> 06

1,8 T 110/120/132/140kW

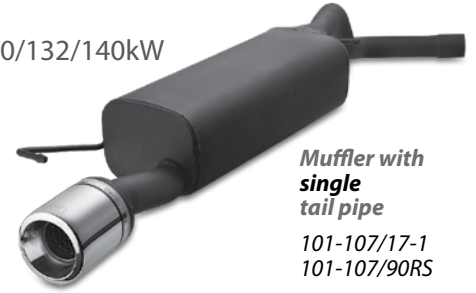

Muffler with **single tail pipe**

101-107/17-1  
101-107/90RS

## AUDI A6 C6

sedan

04 -> 08

2,0 TFSi 125kW

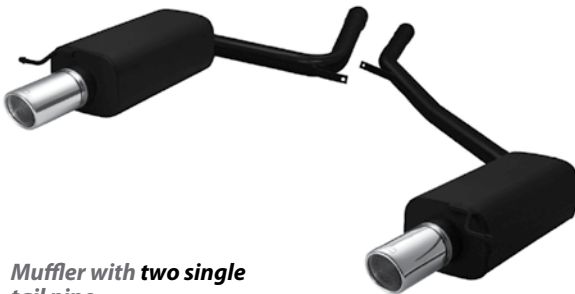

Muffler with **two single tail pipe**

101-317/90RS

## AUDI TT type 8J

07 ->

1,8 TFSI 118kW

2,0 TFSI 147kW



Muffler with **single tail pipe**

101-110/27

Muffler with **two single tail pipes L+R**

101-310/27

## AUDI TT QUATTRO type 8N

99 -> 06

1,8 T 165kW



Muffler with **two single tail pipes**

101-308/16-1

101-308/17-2

101-308/90RS

## AUDI A8 4E QUATTRO

02 -> 10

3,7i 206kW

4,2i 246kW

4,0 TDI 202kW

4,2 TDI 240kW



Two mufflers with **two single tail pipes L+R**

101-311/90RS

set of two mufflers L+R

Two mufflers with **two double tail pipes L+R**

101-411/55

## BMW E30 4 cyl.

sedan, touring

09/87 -> 08/91

316i 73kW

318i 83/85kW



Muffler with **single tail pipe**

102-104/21-1

Muffler with **double tail pipe**

102-204/07-2

## BMW E30 6 cyl.

sedan, touring

**85 -> 90**

**320i** 95kW  
**325i** 125kW



**Muffler with  
single  
tail pipe**

102-106/21-1

**Muffler with  
double  
tail pipe**

102-206/07-2

## BMW E36 is

sedan, touring, cabrio, coupe

**90 -> 97**

**318is** 103kW



**Muffler with  
single  
tail pipe**

102-108/07-2  
102-108/28\*

**Muffler with  
double  
tail pipe**

102-208/07-2\*  
102-208/53\*

\* cutout in bumper necessary

## BMW E36 6 cyl.

sedan, touring, cabrio, coupe

**90 -> 98**

**320i** 110kW\*  
**323i** 125kW (1995->)



**Muffler with  
single  
tail pipe**

102-107/21-1  
102-107/28

**Muffler with  
double  
tail pipe**

102-207/07-2

\* cutout in bumper necessary

## DUPLEX version \*\*

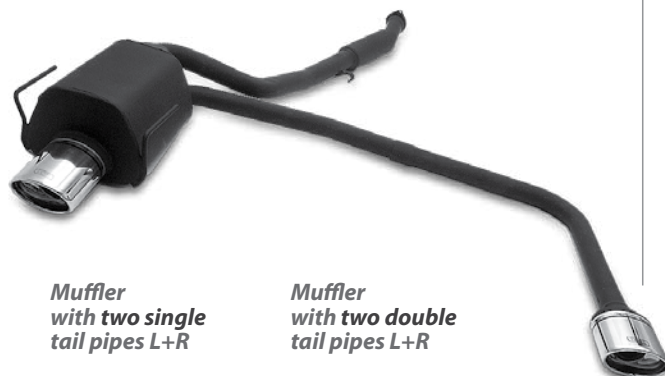

**Muffler  
with two single  
tail pipes L+R**

102-308/28

**Muffler  
with two double  
tail pipes L+R**

102-408/07-2

\*\* the cutout in bumper needs to be filled up

## BMW E36 4 cyl.

sedan, touring, cabrio, coupe

**12/90 -> 12/98**

**316i** 73kW  
**318i** 85kW



**Muffler with  
single  
tail pipe**

102-101/07-2  
102-101/10

**Muffler with  
double  
tail pipe**

102-201/07-2

## BMW E36 325 24V

sedan, touring, cabrio, coupe

**12/90 -> 12/95**

**325 2,5 24V** 141kW



**Muffler with double tail pipe**

102-211/07-2  
102-211/70RS

## BMW E36 compact

**94 -> 00**  
316i 75kW



*Muffler with  
single  
tail pipe*  
102-103/07-2  
102-103/17-1

## BMW E36 compact

**94 -> 00**  
318Ti 103kW



*Muffler with  
single  
tail pipe*  
102-118/07-2  
102-118/90RS

## BMW E36 compact

**94 -> 99**  
323Ti 125kW



*Muffler with  
single  
tail pipe*  
102-126/07-1  
102-126/90RS  
102-126/17-1  
  
*also version M-technik*

## BMW E34

sedan

**09/90 -> 08/95**  
520 24V 110kW



*Muffler with  
single  
tail pipe*  
102-109/21-1

*Muffler with  
double  
tail pipe*  
102-209/07-2

## BMW E34

sedan

**09/87 -> 90**  
525i 125kW



*Muffler with  
single  
tail pipe*  
102-110/21-1

*Muffler with  
double  
tail pipe*  
102-210/07-2

## BMW E34

sedan

**88 -> 96**  
525i 24V 141kW



*Muffler with  
single  
tail pipe*  
102-116/21-1

*Muffler with  
double  
tail pipe*  
102-216/07-2

## BMW E39

sedan, touring

**97 -> 04**  
520 100/110kW  
523 120/125kW  
528 142kW  
525 TDS 105kW



*Muffler with  
single  
tail pipe*  
102-102/28

*Muffler with  
double  
tail pipe*  
102-202/07-1  
102-202/08-1

## BMW E39

sedan

00 -> 03

530d 142kW

Version without M-Packet



Muffler with  
**double tail pipe**

102-230/70RS  
102-230/08-1

## BMW E46

sedan, touring, coupe

99 -> 05

318d 85kW

320d 100/110kW



Muffler with  
**single tail pipe**

102-125/10  
102-125/21-1  
102-125/28

Muffler with  
**double tail pipe**

102-225/70RS  
102-225/07-2

## BMW E46

sedan, touring, coupe

99 -> 05

316i 77/85kW

318i 87/105kW



Muffler with  
**single tail pipe**

102-112/21-1  
102-112/28

Muffler with  
**double tail pipe**

102-212/70RS  
102-212/07-2

## BMW E46 M3

00 -> 05

3,2i 252kW



Muffler with  
**two double tail pipes**

102-423/07-1  
102-423/61

## BMW E46

sedan, touring, coupe

98 -> 05

320i 110kW

323i 125kW

328i 142kW



Muffler with  
**single tail pipe**

102-114/21-1  
102-114/28

Muffler with  
**double tail pipe**

102-214/70RS  
102-214/07-2\*

\* cutout in bumper necessary

## BMW E46 compact

02 -> 05

320td 110kW



Muffler with  
**single tail pipe**

102-115/70RS  
102-115/07-2



## BMW E46 Compact

01 -> 05

316ti 1,8 85kW



Muffler with **single** tail pipe

102-135/90RS

## BMW E46 6-cyl.

sedan, touring, coupe

99 -> 05

320i 125kW

325i 141kW

Silencer with two inlet pipes



Muffler with **double** tail pipe

102-229/70RS

## BMW E46 6-cyl.

Cabrio Convertible

00 -> 05

330i 170kW

Silencer with two inlet pipes



Muffler with **double** tail pipe

102-231/70RS

## BMW E60 / E61

limousine, touring

03 -> 10

520d 120kW

525d 120/130kW

525xd 130kW

530d 170kW

530d 155/160kW

530xd 170kW

Muffler with **single** tail pipe

102-120/21-1  
102-120/27



Muffler with **double** tail pipe

102-220/07-1  
102-220/70RS

## BMW E63

04 -> 10

645i 245kW

Two mufflers with two **single** tail pipes L+R

102-327/27  
102-327/101RS



Two mufflers with two **double** tail pipes L+R

102-427/90RS  
102-427/55\*

\* set of two mufflers

## BMW E82

07 ->

118d 105kW

120d 130kW



Muffler with **single** tail pipe

102-128/21-1

Muffler with **double** tail pipe

102-228/70RS

## BMW E87

04 -> 07

116i 85kW  
118i 95kW  
120i 110kW

Muffler with  
**single**  
tail pipe  
102-117/08-1



## BMW E91

combi

08 -> 13

320D 130kW



Muffler with **double**  
tail pipe  
102-237/70RS

## BMW E87

04 -> 07

120d 120kW



Muffler with **double**  
tail pipe  
102-236/70RS

## BMW F10

sedan

12 ->

525xd; 525d 2,0 160kW

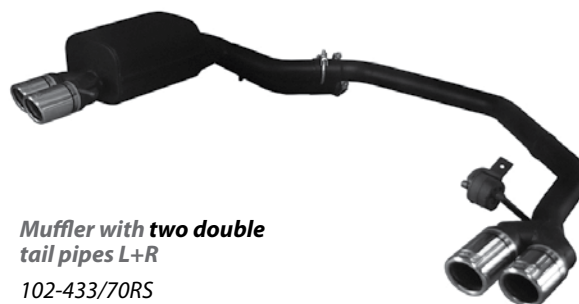

Muffler with **two double**  
tail pipes L+R  
102-433/70RS

## BMW E90

sedan

05 -> 07/2007

318i 95/105kW  
320i 110kW



Muffler with  
**single**  
tail pipe  
102-113/21-1

Muffler with  
**double**  
tail pipe  
102-213/70RS

## BMW F20

10 ->

116i 100kW



Muffler with **single**  
tail pipe  
102-138/70RS

## BMW X6

**09 -> 12**  
3,5i 225kW

*Muffler with two single tail pipes*  
102-322/17-1.2



**3,0D 173kW**

*Muffler with two single tail pipes*  
102-334/17-1.2

## BMW Z3 M43

*roadster*

**98 -> 02**  
1,9 87kW



*Muffler with single tail pipe*  
102-139/28

## CHEVROLET LACETTI

*hatchback*

**04 ->**  
1,4 16V 70kW



*Muffler with single tail pipe*  
132-102/10

*Muffler with double tail pipe*  
132-202/07-2

## CHRYSLER PT Cruiser

**00 -> 10**  
1,6 80kW  
2,0 104kW

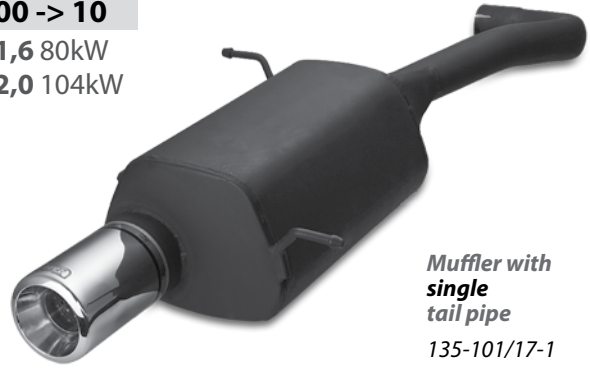

*Muffler with single tail pipe*  
135-101/17-1

## CHRYSLER 300C

*combi*

**04 -> 10**  
5,7 250kW



*Muffler with two single tail pipes*  
135-302/90RS

## CITROEN C2

**03 -> 09**  
1,1 44kW



*Muffler with single tail pipe*  
104-104/07-2  
104-104/17-1

**DUPLEX version \***



*Muffler with two single tail pipes L+R*  
104-304/07-2  
104-304/17-1

\* cutout in bumper necessary



## CITROEN C2

04 -> 09

1,6 VTS  
1,6 VTR



**Muffler with single tail pipe**

104-107/07-2  
104-107/17-1



**DUPLEX version \***

**Muffler with two single tail pipes L+R**

104-307/07-2  
104-307/17-1

\* cutout in bumper necessary

## CITROEN C3

02 -> 09

1,1 44kW



**Muffler with single tail pipe**

104-106/07-2  
104-106/17-1



**DUPLEX version \*\***

**Muffler with two single tail pipes L+R**

104-306/07-2  
104-306/17-1

\* cutout in bumper necessary

## CITROEN C4

hatchback 3D

04 -> 09

1,6 80kW



**Muffler with single tail pipe**

104-105/21-1  
104-105/28

**Muffler with double tail pipe**

104-205/70RS  
104-205/12-1

## CITROEN C4 PICASSO

07 -> 13

1,6 HDi 80/82kW

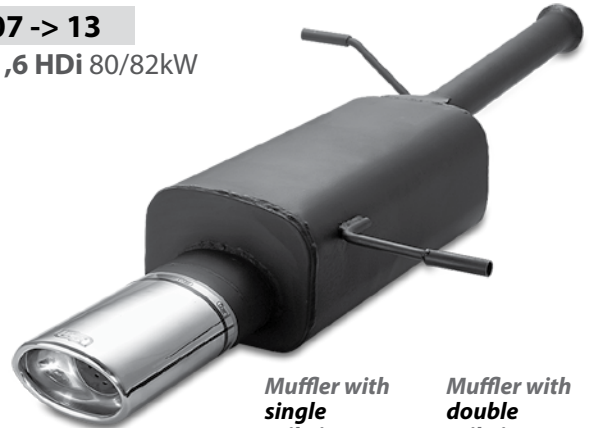

**Muffler with single tail pipe**

104-109/10  
104-109/21-1  
104-109/28

**Muffler with double tail pipe**

104-209/70RS

## CITROEN SAXO

96 -> 04

1,0 37kW  
1,1 44kW  
1,4 55kW  
1,5D 40kW



**Muffler with single tail pipe**

104-101/07-2  
104-101/10

**Muffler with double tail pipe**

104-201/07-2

## CITROEN SAXO VTS

96 -> 01

1,6 VTS 87kW

Set with sport catalytic converter  
for rally version

104-101/R



## CITROEN XSARA

hatchback

07/97 -> 02/99

1,4i 55kW

1,6i 65kW

1,8i 66/74kW



Muffler with  
single  
tail pipe

104-102/07-2  
104-102/10  
104-102/17-1

## CITROEN XSARA

hatchback

03/99 -> 03

1,4i 55kW

1,6i 65kW

1,6i 16V 81kW

1,8i 66/74kW

1,8i 16V 74/81kW



Muffler with  
single  
tail pipe

104-103/07-2  
104-103/17-1

## DACIA LOGAN

sedan

05 -> 12

1,4 55kW

1,6 64kW

1,6 16V 77kW

1,5 dCi 50kW



Muffler with  
single  
tail pipe

131-101/07-2  
131-101/17-1  
131-101/22  
131-101/90RS

**DUPLEX version \***

131-301/07-2  
131-301/17-1  
131-301/22  
131-301/90RS

\* cutout in bumper necessary

## DAEWOO LANOS

hatchback

97 -> 08

1,3i 55kW

1,5 63/81kW

1,6i 16V 78kW

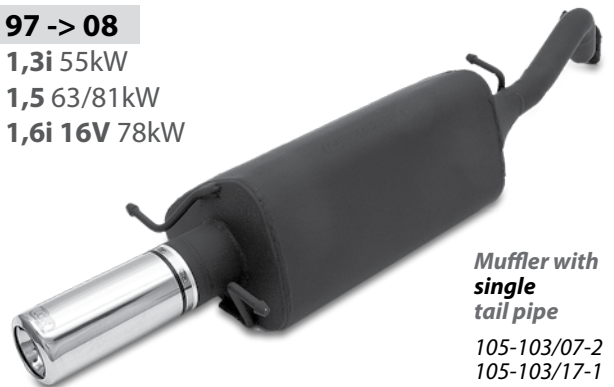

Muffler with  
single  
tail pipe

105-103/07-2  
105-103/17-1

## DAEWOO LANOS

sedan

97 -> 08

1,3i 55kW

1,5 63/81kW

1,6i 16V 78kW



Muffler with  
single  
tail pipe

105-104/07-2  
105-104/17-1

## FIAT 500

07 ->  
1,2 51kW  
1,4 74kW

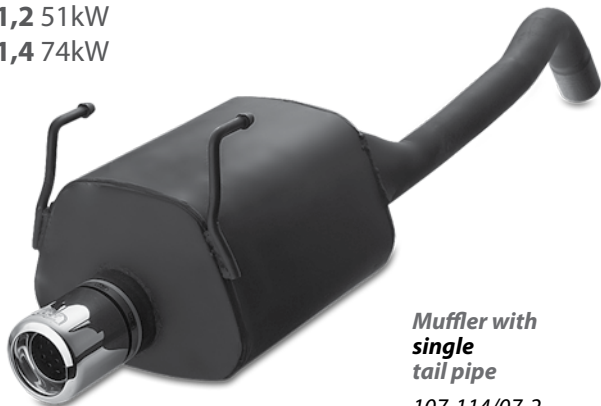

*Muffler with single tail pipe*

107-114/07-2  
107-114/17-1

## FIAT BRAVO\*

97 -> 01  
1,4 12V 55/59kW  
1,6 16V 66/76kW



*Muffler with single tail pipe*

107-101/10  
107-101/21-1

*Muffler with double tail pipe*

107-201/07-2  
107-201/12-1

\* rear muffler

## FIAT 500 ABARTH

09 ->  
1,4 T 99kW



*Muffler with two single tail pipes L+R*

107-315/101RS

## FIAT BRAVO II

07 -> 12  
1,4i 66/88kW  
1,6 JTD 66/77/88kW  
1,9 JTD 88kW



*Muffler with single tail pipe*

107-116/10-1  
107-116/21-1  
107-116/27

*Muffler with double tail pipe*

107-216/70RS

## FIAT BRAVA\*

97 -> 01  
1,4 12V 55/59kW  
1,6 16V 66/76kW



*Muffler with single tail pipe*

107-110/10-1  
107-110/21-1

*Muffler with double tail pipe*

107-210/07-2  
107-210/12-1

\* rear muffler

## FIAT BRAVO II

07 -> 12  
1,4 T-JET 88/110kW  
1,6 TD MultiJet 88kW



*Muffler with single tail pipe*

107-117/10-1  
107-117/21-1  
107-117/27

*Muffler with double tail pipe*

107-217/70RS

\* version with cutout in bumper

## FIAT CINQUECENTO

92 -> 98

0,7 22kW  
0,9 29kW



*Muffler with  
single  
tail pipe*

107-102/07-2  
107-102/10  
107-102/17-1  
107-102/R rally version

## FIAT CINQUECENTO SPORTING

92 -> 98

1,1 40kW



*Muffler with  
single  
tail pipe*

107-103/07-2  
107-103/10  
107-103/17-1  
107-103/R rally version

## FIAT PANDA

03 -> 12

1,1 40kW  
1,2 44kW  
1,3 JTD 51kW/55kW



*Muffler with  
single  
tail pipe*

107-108/07-2  
107-108/10

## FIAT PANDA 100HP

03 -> 12

1,4 74kW



*Muffler with  
single  
tail pipe*

107-113/07-2  
107-113/17-1

## FIAT FREEMONT FWD

11 ->

2,0 125kW

*Muffler with  
single  
tail pipe*

107-119/90RS

### DUPLEX version

*Muffler  
with two single  
tail pipes L+R*

107-319/90RS

## FIAT PANDA

03 -> 12

1,1 40kW  
1,2 44kW  
1,3 JTD 51kW/55kW



*Muffler with  
single  
tail pipe*

107-108/07-2  
107-108/10

## FIAT PANDA 4X4

03 -> 12

1,2 44kW

*Muffler with  
single  
tail pipe*

107-112/07-2  
107-112/10

### DUPLEX version

*Muffler with two single  
tail pipes L+R*

107-312/07-2

## FIAT PUNTO I\*

93 -> 98

1,1 40kW  
 1,2 43/55kW  
 1,2 16V 63kW  
 1,6 66kW  
 1,4GT\*\* Turbo 100kW



**Muffler with single tail pipe**

107-104/07-2  
 107-104/10

\* rear muffler  
 \*\* available only for special order

## FIAT GRANDE PUNTO, PUNTO EVO

05 ->

1,2 48kW  
 1,4 57kW  
 1,4 16V 70kW



**Muffler with single tail pipe**

107-111/10  
 107-111/21-1  
 107-111/28

**Muffler with double tail pipe**

107-211/07-2  
 107-211/10

## FIAT PUNTO II

99 -> 06

1,2 44kW  
 1,2 16V 59kW  
 1,8HGT\* 96kW  
 1,9JTD\* 59/63kW



**Muffler with single tail pipe**

107-105/07-2  
 107-105/10

**Muffler with double tail pipe**

107-205/07-2  
 107-205/12-1

\* available only for special order



**DUPLEX version**

**Muffler with two single tail pipes L+R**  
 107-305/10

**Muffler with two double tail pipes L+R**  
 107-405/70RS



**DUPLEX version**

**Muffler with two single tail pipes L+R**  
 107-311/28

**Muffler with two double tail pipes L+R**  
 107-411/70RS

## FIAT GRANDE PUNTO ABARTH

07 ->

1,4 114kW



**Muffler with double tail pipe**

107-220/70RS



## FIAT SEDICI

**06 -> 12**

1,6i 79/89kW

**Muffler with single tail pipe**

107-118/07-2  
107-118/10-1

**1,9D 88kW**

**Muffler with single tail pipe**

107-121/07-2

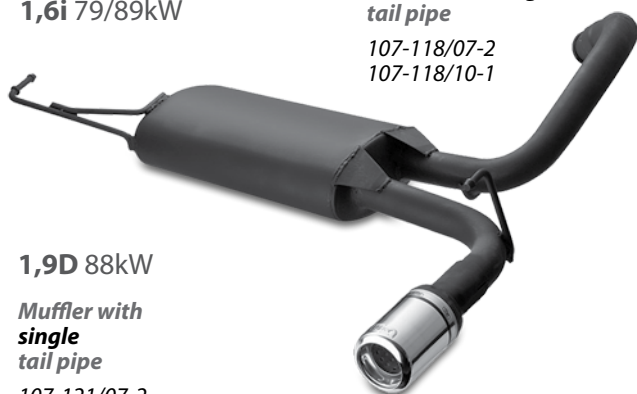

## FIAT SEICENTO SPORTING

**98 -> 10**

1,1 40kW

**Muffler with single tail pipe**

107-107/07-2  
107-107/17-1\*

107-107/R rally version

\* cutout in bumper necessary



## FIAT SEICENTO

**98 -> 10**

0,9 29kW

1,1 40kW

**Muffler with single tail pipe**

107-106/07-2  
107-106/10  
107-106/17-1  
107-106/R rally version



**DUPLEX version**

**Muffler with two single tail pipes L+R**

107-306/07-2



## FIAT STILO

hatchback 3D or 5D

**01 -> 07**

1,2 59kW

1,6 76kW

1,8 98kW

2,4 125kW\*

1,9JTD 59/85/103kW\*

**Muffler with double tail pipe**

107-209/10-1  
107-209/12-1

**IMPORTANT! MUST BE SPECIFIED**  
which version is required - 5D or 3D (door)

\* available only for special order

**Muffler with single tail pipe**

107-109/10-1  
107-109/27

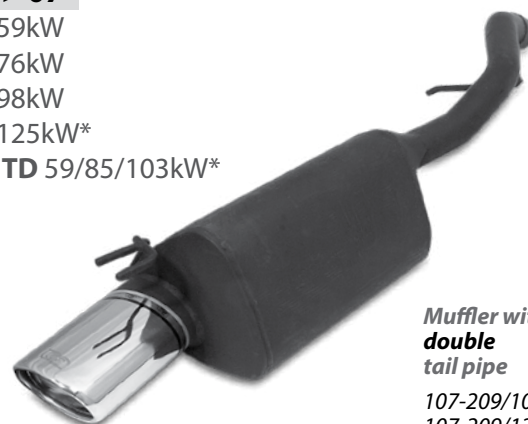

**DUPLEX version \*\***

**Muffler with two single tail pipes L+R**

107-309/27

**Muffler with two double tail pipes L+R**

107-409/12-1

\*\* only 3 door version

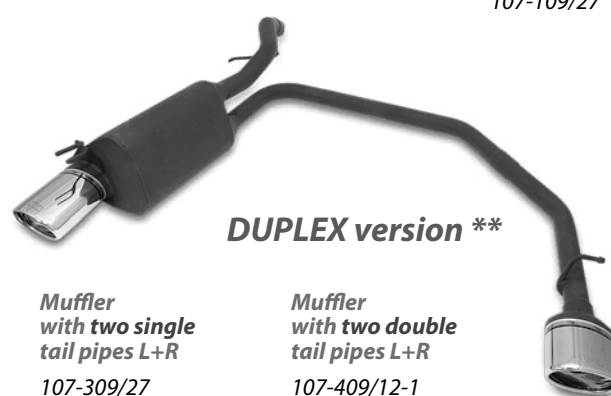

## FORD COUGAR

**98 -> 02**  
2,5 V6 125kW



Two mufflers  
with two single  
tail pipes L+R  
108-315/07-2

## FORD FIESTA III

**92 -> 96**  
1,3 44kW  
1,4i 51/54kW



Muffler with  
single  
tail pipe  
108-103/07-2

## FORD ESCORT

*hatchback, cabrio*

**01/95 -> 09/01**  
1,6i 16V 66kW



Muffler with  
single  
tail pipe  
108-101/07-2  
108-101/10  
108-101/17-1

## FORD FIESTA IV, V

**96 -> 02**  
1,3 44kW  
1,4i 51/54kW



Muffler with  
single  
tail pipe  
108-104/10  
108-104/17-1

## FORD ESCORT

*combi*

**01/95 -> 00**  
1,6i 16V 66kW



Muffler with  
single  
tail pipe  
108-102/101  
108-102/26

Muffler with  
double  
tail pipe  
108-202/07-2

## FORD FIESTA VI

**02 -> 05**  
1,3 51kW  
1,4 16V 59kW



Muffler with  
single  
tail pipe  
108-110/07-2

Muffler with  
double  
tail pipe  
108-210/12-1

## FORD FIESTA VII

**08 ->**  
 1,25 44/60kW  
 1,4 16V 90kW



**Muffler with single tail pipe**

108-119/10  
 108-119/21-1

**Muffler with double tail pipe**

108-219/70RS

## FORD FOCUS I

sedan

**98 -> 05**  
 1,4i 55kW  
 1,6i 74kW  
 1,8i 85kW  
 2,0i 96kW



**Muffler with single tail pipe**

108-107/07-2  
 108-107/17-1

## FORD FOCUS I

hatchback

**98 -> 05**  
 1,4i 55kW  
 1,6i 74kW  
 1,8i 85kW  
 2,0i 96kW

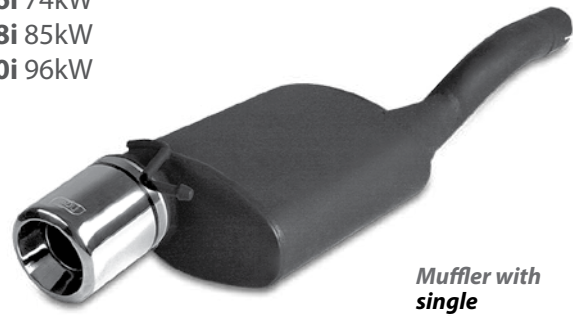

**Muffler with single tail pipe**

108-105/07-2  
 108-105/17-1

**DUPLEX version \***

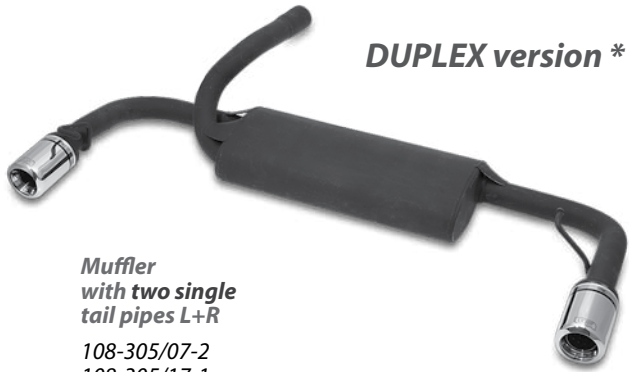

**Muffler with two single tail pipes L+R**

108-305/07-2  
 108-305/17-1

\* cutout in bumper necessary

## FORD FOCUS I

combi

**98 -> 05**  
 1,4i 55kW  
 1,6i 74kW  
 1,8i 85kW  
 2,0i 96kW



**Muffler with single tail pipe**

108-106/07-2  
 108-106/17-1

**DUPLEX version**

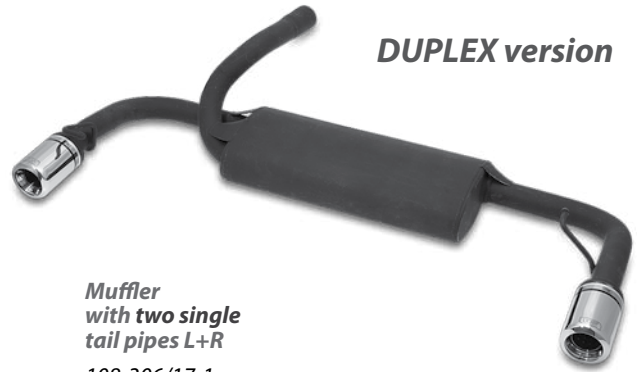

**Muffler with two single tail pipes L+R**

108-306/17-1



## FORD FOCUS II

*hatchback*

**05 -> 10**

1,4 16V 59kW  
1,6 16V 74/85kW  
1,8 16V 92kW  
2,0 16V 107kW  
1,8 TDCi 85 kW

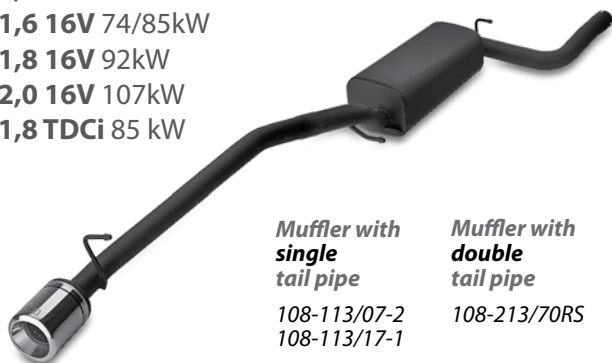

*Muffler with  
single  
tail pipe*

108-113/07-2  
108-113/17-1

*Muffler with  
double  
tail pipe*

108-213/70RS

## FORD FOCUS III

*hatchback*

**10 -> 14**

1,6 EcoBoost 100kW



*Muffler with two single  
tail pipes L+R*

108-327/60

\* cutout in bumper necessary

## FORD FOCUS II

*sedan*

**05 -> 10**

1,4 16V 59kW  
1,6 16V 74/85kW  
1,8 16V 92kW  
2,0 16V 107kW  
1,8 TDCi 85 kW

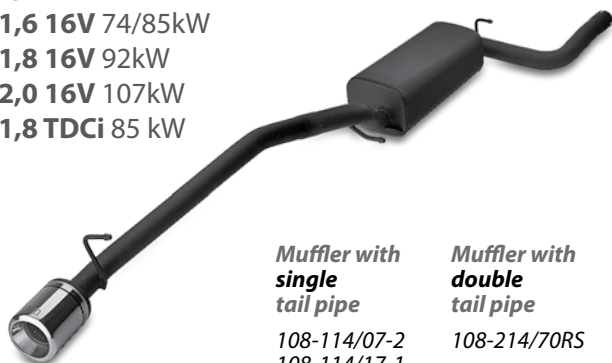

*Muffler with  
single  
tail pipe*

108-114/07-2  
108-114/17-1

*Muffler with  
double  
tail pipe*

108-214/70RS

## FORD FOCUS C-MAX

**05 -> 10**

1,6 16V 74/85kW  
1,8 16V 92kW  
2,0 16V 107kW  
1,8 TDCi 85 kW

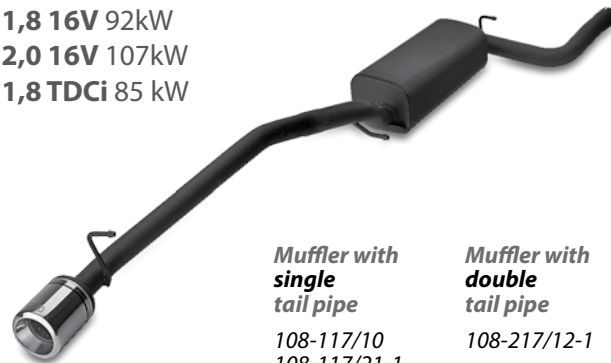

*Muffler with  
single  
tail pipe*

108-117/10  
108-117/21-1

*Muffler with  
double  
tail pipe*

108-217/12-1

## FORD FOCUS II

*combi*

**05 -> 10**

1,4 16V 59kW  
1,6 16V 74/85kW  
1,8 16V 92kW  
2,0 16V 107kW  
1,8 TDCi 85 kW

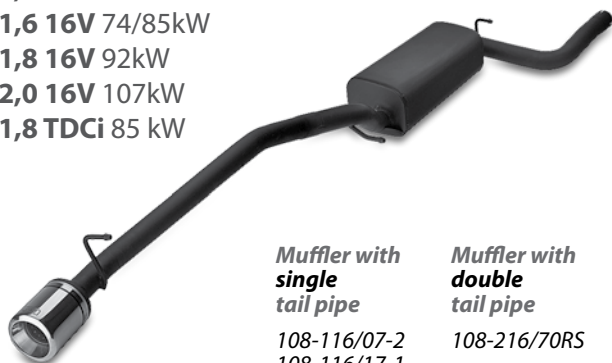

*Muffler with  
single  
tail pipe*

108-116/07-2  
108-116/17-1

*Muffler with  
double  
tail pipe*

108-216/70RS

## FORD S-MAX

**06 -> 10**

2,0 TDCi 103kW



*Muffler with single  
tail pipe*

108-125/27

## FORD FUSION

**06/02 -> 05**

1,4 59kW  
1,6 74kW

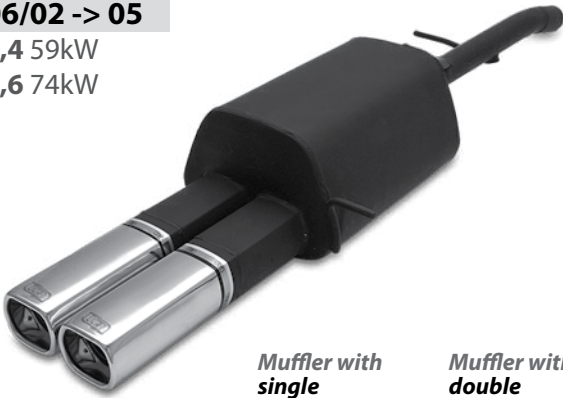

*Muffler with  
single  
tail pipe*

108-111/10

*Muffler with  
double  
tail pipe*

108-211/12-1

## FORD KA

**09/96 -> 08**

1,3 37/44kW



*Muffler with  
single  
tail pipe*

108-108/07-2

## FORD KA II

**08 -> 13**

1,2 51kW  
1,3 TDCi 55kW



*Muffler with  
single  
tail pipe*

108-120/07-2  
108-120/10

## FORD MONDEO mk3

sedan, hatchback

**10/00 -> 06**

2,5 V6 125kW



**DUPLEX version**

*Two mufflers  
with two single  
tail pipes L+R*

108-318/21-1  
108-318/27

*Two mufflers  
with two double  
tail pipes L+R*

108-418/07-2

## FORD MONDEO mk3

sedan, hatchback

**10/00 -> 06**

1,8i 16V 81/92kW  
2,0i 16V 107kW



*Muffler with  
single  
tail pipe*

108-112/10  
108-112/21-1  
108-112/26

*Muffler with  
double  
tail pipe*

108-212/07-2

**DUPLEX version**

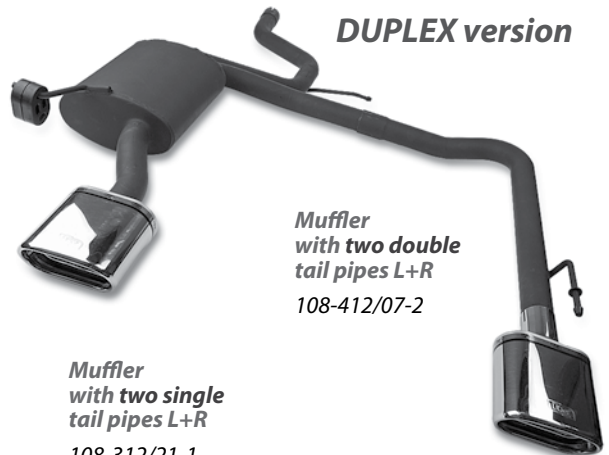

*Muffler  
with two double  
tail pipes L+R*

108-412/07-2

*Muffler  
with two single  
tail pipes L+R*

108-312/21-1  
108-312/28

## FORD MONDEO mk3

combi

**10/00 -> 02/07**

1,8i 81/92kW

2,0i 107kW

2,0 TDCi 66/85/96kW

2,2 TDCi 114kW

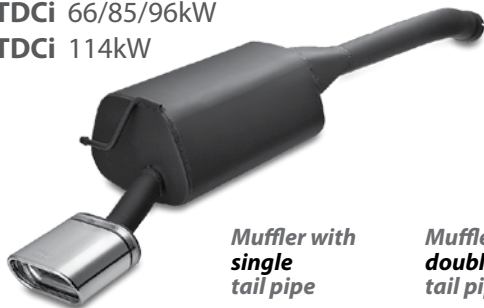

Muffler with **single** tail pipe

108-121/10  
108-121/21-1

Muffler with **double** tail pipe

108-221/70RS



**DUPLEX version**

Muffler with **two double** tail pipes L+R

108-421/70RS

Muffler with **two single** tail pipes L+R

108-321/10  
108-321/21-1

## FORD MONDEO mk4

sedan, hatchback, combi

**02/07 -> 14**

1,8 TDCi 74kW

2,0 TDCi 96/103kW



Muffler with **single** tail pipe

108-122/10  
108-122/21-1

Muffler with **double** tail pipe

108-222/12-1  
108-222/70RS

## FORD MONDEO mk4

sedan, hatchback, combi

...continued



**DUPLEX version**

Two mufflers with **two single** tail pipes L+R

108-322/10  
108-322/21-1

Two mufflers with **two double** tail pipes L+R

108-422/12-1  
108-422/70RS

## FORD MONDEO ST220

combi

**02 -> 07**

3,0 166kW



**DUPLEX version**

Muffler with **two single** tail pipes L+R

108-324/90RS

## FORD KUGA

**08 -> 13**

2,0 TDCi 103/120kW



Muffler with **two single** tail pipes L+R

108-323/17-1  
108-323/101RS

## FORD PUMA

97 -> 02

1,4 16V 66kW  
1,7 16V 92kW



**Muffler with single tail pipe**  
108-109/10  
108-109/26



**DUPLEX version \***

**Muffler with two single tail pipes L+R**  
108-309/17-1

\* cutout in bumper necessary

## HONDA ACCORD VI

sedan

10/98 -> 02

1,6 85kW  
1,8iS 16V 100kW  
2,0i 16V 108kW  
2,3i 16V 113kW



**Muffler with single tail pipe**  
110-101/21-1  
110-101/26

**Muffler with double tail pipe**  
110-201/07-2  
110-201/10



**DUPLEX version \***

**Muffler with two single tail pipes L+R**  
110-301/21-1  
110-301/27

\* cutout in bumper necessary

## HONDA ACCORD VII

sedan

02 -> 08

2,0i 114kW



**Muffler with single tail pipe**  
110-113/08-1  
110-113/101RS

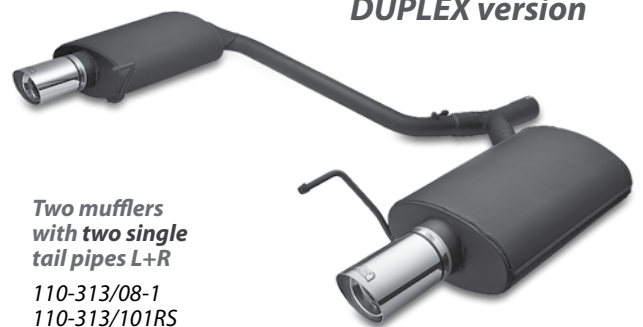

**DUPLEX version**

**Two mufflers with two single tail pipes L+R**  
110-313/08-1  
110-313/101RS

## HONDA ACCORD VII

combi

02 -> 08

2,2i-CTDi 103kW



**Muffler with single tail pipe**  
110-116/08-1  
110-116/09RS  
110-116/101RS



**DUPLEX version**

**Two muffler with two single tail pipes L+R**  
110-316/08-1  
110-316/90RS  
110-316/101RS

## HONDA ACCORD VII TYPE-S CM2

combi

02 -> 08

2,4 140kW



Muffler with **two single tail pipes L+R**  
110-318/90RS

## HONDA ACCORD VIII

sedan

08 -> 12

2,4i 148kW



Two mufflers with **two single tail pipes L+R**  
110-312/08-1  
110-312/101RS

## HONDA CIVIC V

hatchback

92 -> 96

1,3i 16V 55kW

1,5i 16V 66kW

1,6i 16V 92kW



Muffler with **single tail pipe**

110-102/07-2  
110-102/10  
110-102/17-1  
110-102/21-1

Muffler with **double tail pipe**

110-202/07-2



**DUPLEX version**

Muffler with **two single tail pipes L+R**

110-302/21-1

Muffler with **two double tail pipes L+R**

110-402/13DTM

## HONDA CIVIC V

sedan, coupe type EJ1, EJ2, EJ6

92 -> 96

1,5i 16V 66/74kW

1,6i 16V 92kW



Muffler with **single tail pipe**

110-108/07-2  
110-108/10  
110-108/17-1

## HONDA CIVIC VI

hatchback 3D

96 -> 01

1,4 16V 55/66kW

1,5 VTEC-E 16V 85kW

1,6 16V 85kW



Muffler with **single tail pipe**

110-103/07-2  
110-103/10  
110-103/17-1  
110-103/26



## HONDA CIVIC VI

*hatchback 5D*

**95 -> 01**

**1,4 16V** 55/66kW

**1,5 VTEC-E 16V** 66/85kW

**1,6 16V** 83/93kW



**Muffler with  
single  
tail pipe**

110-106/07-2  
110-106/10  
110-106/17-1  
110-106/26

## HONDA CIVIC VII

*coupe*

**02 -> 06**

**1,7 88/92kW**



**Muffler with  
single  
tail pipe**

110-115/07-2  
110-115/10  
110-115/17-1

**Muffler with  
double  
tail pipe**

110-215/07-2  
110-215/12-1

## HONDA CIVIC VI

*sedan*

**96 -> 01**

**1,4** 66kW

**1,5 VTEC** 84kW

**1,6** 77kW



**Muffler with  
single  
tail pipe**

110-110/07-2  
110-110/10  
110-110/17-1

## HONDA CIVIC VIII

*hatchback*

**06 -> 11**

**2,0 Type-R** 148kW



**Muffler  
110-311  
without tail pipes**

assembly with original  
tail pipes or with any other  
Ulter-Sport tail pipes with  
assembly cup of 50mm diameter

## HONDA CIVIC VII

*hatchback*

**02 -> 06**

**1,4 16V** 66kW

**1,6 16V** 81kW



**Muffler with  
single  
tail pipe**

110-107/07-2  
110-107/10  
110-107/26

**Muffler with  
double  
tail pipe**

110-207/07-2  
110-207/12-1

## HONDA CRV

**97 -> 01**

**2,0** 94kW



**Muffler with single  
tail pipe**

110-105/17-1

## HONDA CRX

87 -> 92

1,6 16V 91/96kW



Muffler with  
**single**  
tail pipe

110-104/10  
110-104/21-1

Muffler with  
**double**  
tail pipe

110-204/07-2



**DUPLEX version**

Muffler  
with two single  
tail pipes L+R

110-304/21-1

Muffler  
with two double  
tail pipes L+R

110-404/13DTM

## HONDA PRELUDE IV gen.

91 -> 96

2,0i 98kW  
2,2Vtec 136kW  
2,3i 118kW



Muffler with  
**single**  
tail pipe

110-114/21-1  
110-114/50

Muffler with  
**double**  
tail pipe

110-214/70RS  
110-214/07-2



**Middle**  
muffler

110-114/SR

## HYUNDAI ACCENT

*hatchback*

09/94 -> 10/99

1,3i 44/55/62kW  
1,5i 65/73kW



Muffler with  
**single**  
tail pipe

111-101/07-2  
111-101/17-1

## HONDA CRX DEL SOL

09/92 -> 98

1,6 16V 92kW



Muffler with  
**single**  
tail pipe

110-109/17-1  
110-109/21-1

Muffler with  
**double**  
tail pipe

110-209/07-2  
110-209/10



**DUPLEX version**

Muffler  
with two single  
tail pipes L+R

110-309/17-1

Muffler  
with two double  
tail pipes L+R

110-409/13DTM

## HYUNDAI COUPE type GK

03 -> 06

2,0 103kW  
2,7 V6 123kW



Two mufflers  
with two single  
tail pipes L+R

111-302/17-1  
111-302/101RS

## KIA PICANTO

*hatchback*

**04 -> 11**

1,0 45kW

1,1 48kW



**Muffler with  
single  
tail pipe**

112-101/10

**Muffler with  
double  
tail pipe**

112-201/07-2  
112-201/10

## MAZDA 323

323F, 323C\*, 323P

**04/94 -> 04/98**

1,3 16V 54kW

1,5 16V 66kW



**Muffler with  
single  
tail pipe**

116-101/10  
116-101/21-1  
116-101/28

**Muffler with  
double  
tail pipe**

116-201/07-2  
116-201/10  
116-201/70RS



**DUPLEX version \*\***

**Muffler  
with two single  
tail pipes L+R**

116-301/21-1

**Muffler  
with two double  
tail pipes L+R**

116-401/70RS

\* bumper trimming necessary

\*\* cutout in bumper necessary

## MAZDA 323

323F, 323C\*, 323P

**04/94 -> 04/98**

1,8 16V 85kW

2,0 V6 106kW



**Muffler with  
single  
tail pipe**

116-106/10  
116-106/21-1  
116-106/28

**Muffler with  
double  
tail pipe**

116-206/07-2  
116-206/10  
116-206/70RS



**DUPLEX version \*\***

**Muffler  
with two single  
tail pipes L+R**

116-306/21-1

**Muffler  
with two double  
tail pipes L+R**

116-406/70RS

\* bumper trimming necessary

\*\* cutout in bumper necessary

## MAZDA MX3

**91 -> 99**

1,8 V6 97/100kW



**Muffler with  
single  
tail pipe**

116-102/10  
116-102/21-1

**Muffler with  
double  
tail pipe**

116-202/07-2  
116-202/70RS

## MAZDA MX5 type NB

98 -> 05

1,6 81kW  
1,8 103kW

**Muffler with  
single  
tail pipe**

116-103/17-1  
116-103/26  
116-103/90RS

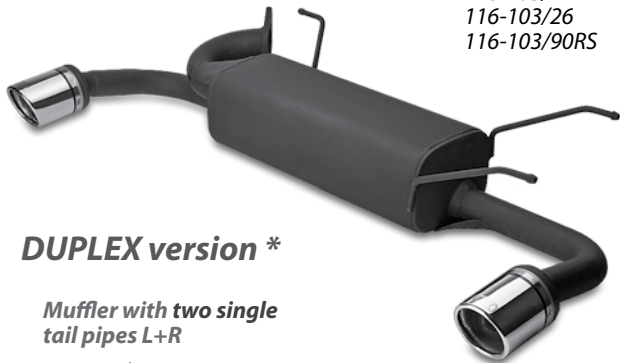

**DUPLEX version \***

**Muffler with two single  
tail pipes L+R**

116-303/17-1  
116-303/26  
116-303/90RS

\* cutout in bumper necessary

## MAZDA 6

sedan, hatchback

02 -> 07

3,0 V6 162kW



**Two mufflers  
with two single  
tail pipes L+R**

116-307/27  
116-307/90RS

## MAZDA 6

sedan, hatchback

07 -> 12

1,8 88kW  
2,0 108kW  
2,0TD 89/105kW  
2,5 125kW

**Muffler with  
single tail pipe**

116-105/27  
116-105/90RS



**DUPLEX version**

**Two mufflers  
with two single  
tail pipes L+R**

116-305/27  
116-305/90RS



## MAZDA MX5 type NC

05 -> 09

1,8 93kW



**Muffler with  
two single  
tail pipes**

116-309/07-2

## MAZDA 6

combi

02 -> 07

1,8i 88kW  
2,0i 103kW  
2,0 CiTD 88/100kW



**Muffler with  
single tail pipe**

116-104/10-1  
116-104/21-1  
116-104/28

**Muffler with  
double tail pipe**

116-204/70RS  
116-204/07-2

## MERCEDES A-classe, B-classe

05 ->

A150, B150 1,5 70kW  
A160, B160 1,5 70kW  
A170, B170 1,7 85kW  
A180, B180 1,7 85kW  
A200, B200 2,0 100kW

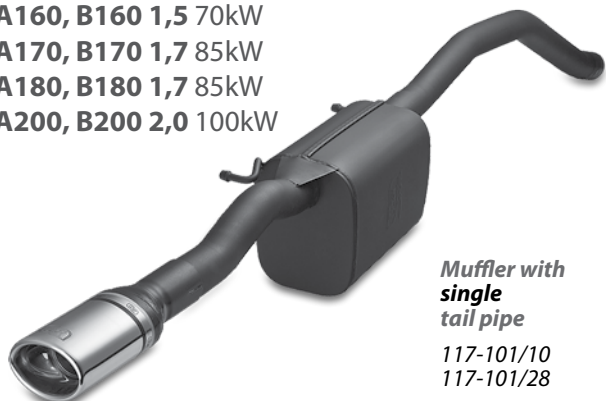

**Muffler with  
single  
tail pipe**

117-101/10  
117-101/28

## MERCEDES E-classe W211

11/01 -> 08

E270 2,7 CDI 120/130kW  
E320 3,2 CDI 130/150kW



### DUPLEX version

Two mufflers with two single tail pipes L+R

117-302/28  
117-302/21-1

Two mufflers with two double tail pipes L+R

117-402/07-1  
117-402/55

## MERCEDES E350

coupe

09 -> 10

E350 3,0 V6 170kW



Muffler with two single tail pipes L+R

117-308/27

## MERCEDES VITO

96 -> 03

VITO 112 CDi 90kW\*



Muffler with two single tail pipes L+R

117-VITO112

\* assembly set for Duplex version (without tail pipes)

## MINI ONE, MINI COOPER

00 -> 06

1,4 70kW  
1,6 66/85kW

Only versions MINI R50, R53



Muffler with single tail pipe

133-101/07-2

## MINI COOPER MK II

67 -> 00

1,3 39/45/46kW

set with middle muffler tail pipe in the middle of the bumper



Muffler with single tail pipe

133-102/21-1

Muffler with double tail pipe

133-202/70RS  
133-202/13DTM

## MINI COOPER S

02 -> 06

1,6 120/125kW



Two mufflers with two single tail pipes L+R

133-303/07-2

## MITSUBISHI CARISMA I

sedan, hatchback

**95 -> 99**

1,6 66/74kW  
1,8i 85kW  
1,8 GDI 90/92kW  
1,9 TD 66/75/85kW

**Muffler with  
single  
tail pipe**

118-108/07-2  
118-108/10  
118-108/21-1  
118-108/26



**Muffler with  
double  
tail pipe**

118-208/07-2

## MITSUBISHI GALANT

sedan

**97 -> 06**

2,0 100kW  
2,5 V6 120kW  
2,4 GDI 110kW

**Muffler with  
single  
tail pipe**

118-107/07-2  
118-107/16  
118-107/17-1  
118-107/90RS



## MITSUBISHI CARISMA II

sedan, sportback

**99 -> 04**

1,8 16V 85kW

**Muffler with  
single  
tail pipe**

118-106/10  
118-106/21-1  
118-106/26



**Muffler with  
double  
tail pipe**

118-206/07-2

## MITSUBISHI LANCER EVO VII

**01 -> 04**

2,0 206kW

**Muffler with  
single  
tail pipe**

NRS 118-101/16-1  
NRS 118-101/17-2

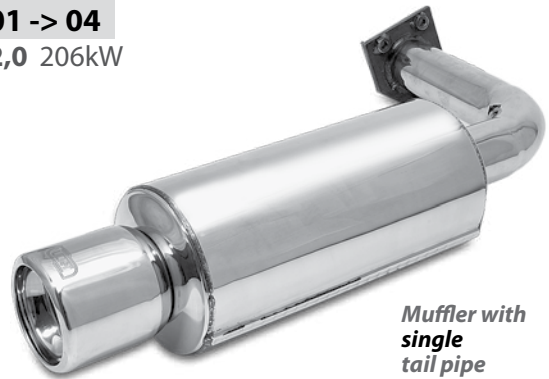

## MITSUBISHI GALANT

combi

**97 -> 06**

2,0 100kW  
2,5 V6 120kW  
2,4 GDI 110kW

**Muffler with  
single  
tail pipe**

118-105/21-1  
118-105/26  
118-105/90RS



## MITSUBISHI LANCER VIII

sedan

**00 -> 07**

1,6i 72kW  
2,0i 99kW

**Muffler with  
single  
tail pipe**

118-104/07-2  
118-104/17-1

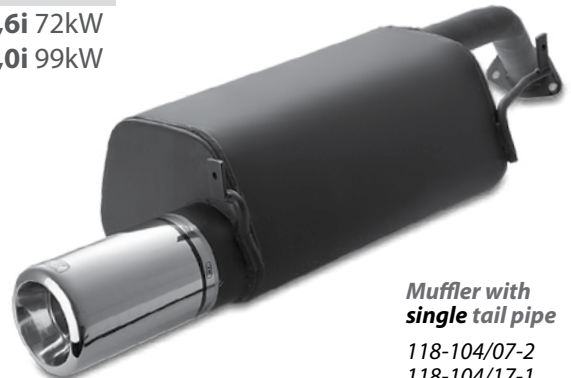

## MITSUBISHI LANCER IX

sedan, hatchback

**07 -> 12**

1,5 16V 80kW  
1,8 16V 105kW

Muffler with  
single tail pipe

118-103/17-1  
118-103/27  
118-103/90RS



**DUPLEX version**

Muffler  
with two single  
tail pipes L+R

118-302/17-1  
118-302/26  
118-302/27

Muffler  
with two double  
tail pipes L+R

118-402/70RS

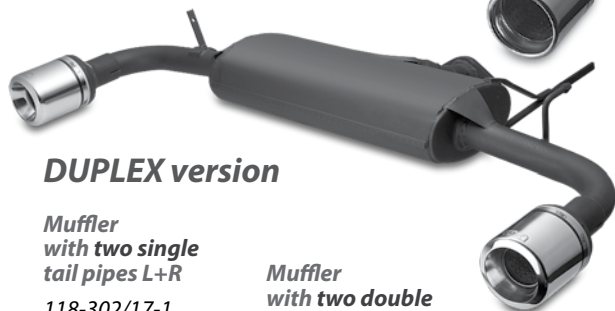

## MITSUBISHI PAJERO V80 LWB

**07 -> 12**

3,2 DID 125/147kW  
3,8 V6 184kW

Two single  
tail pipes L+R  
118-PAJERO/26

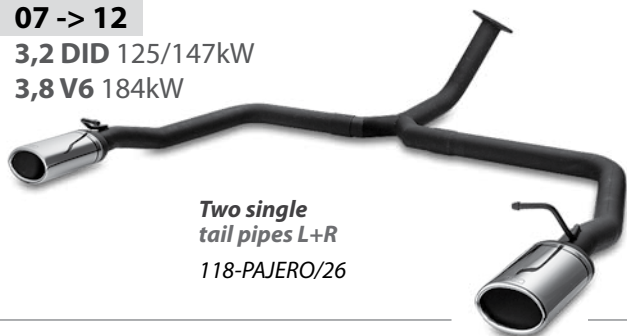

## NISSAN 100NX

**10/90 -> 96**

1,6 16V 66/70/75kW

Muffler with  
single  
tail pipe

119-107/21-1

Muffler with  
double  
tail pipe

119-207/07-2



## NISSAN 350Z

**03 -> 09**

3,5 V6 206/221kW

Muffler  
with two single  
tail pipes L+R

119-306/27  
119-306/90RS



## NISSAN 370Z

**09 ->**

3,7 243kW

Muffler with  
two single  
tail pipes L+R

119-309/27\*



## NISSAN ALMERA type N15

hatchback

**07/95 -> 02/00**

1,4 55/64kW  
1,6 66/73kW  
2,0 D 55kW

Muffler with  
single  
tail pipe

119-101/07-2  
119-101/17-1

Muffler with  
double  
tail pipe

119-201/07-2



M-N

## NISSAN ALMERA type N16

*hatchback*

**02/00 -> 06**

1,5i 16V 72kW  
1,8i 16V 84kW



*Muffler with  
single  
tail pipe*

119-102/07-2  
119-102/17-1

## NISSAN PRIMERA type P10

*sedan, hatchback*

**06/90 -> 05/96**

2,0i 89kW  
2,0i 16V GT 110kW  
2,0i 16V 85kW/92kW



*Muffler with  
single tail pipe*

119-104/21-1

*Muffler with  
double tail pipe*

119-204/07-2

## NISSAN ALMERA type N16

*sedan*

**02/00 -> 06**

1,5i 16V 72kW  
1,8i 16V 84kW



*Muffler with  
single  
tail pipe*

119-105/07-2  
119-105/10

*Muffler with  
double  
tail pipe*

119-205/07-2

## NISSAN JUKE

**10 ->**

1,6T 140kW



*Muffler with  
single tail pipe*

119-108/07-2  
119-108/90RS

## NISSAN MICRA type K12

**11/02 -> 10**

1,0i 16V 48kW  
1,2i 16V 59kW  
1,4i 16V 65kW

*Tail pipe in the middle  
of the bumper*



*Muffler with  
single  
tail pipe*

119-103/07-2  
119-103/21-1

## OPEL ADAM

**13 ->**

1,4 74kW



*Muffler with  
single  
tail pipe*

120-141/10-1



## OPEL ASTRA F

sedan

**91 -> 03/96**

1,4 44/55/60kW  
 1,6i 52/55/74kW  
 1,6i 16V 74kW  
 1,8 66kW  
 1,8i 16V 85/92kW  
 2,0 85kW



Muffler with **single** tail pipe

120-102/07-2  
 120-102/10

Muffler with **double** tail pipe

120-202/07-2

## OPEL ASTRA F

hatchback

**91 -> 03/96**

1,4 44/55/60kW  
 1,6i 52/55/74kW  
 1,6i 16V 74kW  
 1,8 66kW  
 1,8i 16V 85/92kW  
 2,0 85kW



Muffler with **single** tail pipe

120-101/07-2  
 120-101/10

Muffler with **double** tail pipe

120-201/07-2

## OPEL ASTRA F CLASSIC

hatchback

**04/96 -> 02**

1,4 60kW  
 1,4 16V 66kW  
 1,6i 52/55kW  
 1,6i 16V 74kW



Muffler with **single** tail pipe

120-103/07-2  
 120-103/10

Muffler with **double** tail pipe

120-203/07-2

## OPEL ASTRA F CLASSIC

sedan

**04/96 -> 02**

1,4 60kW  
 1,4 16V 66kW  
 1,6i 52/55kW  
 1,6i 16V 74kW



Muffler with **single** tail pipe

120-104/07-2  
 120-104/10

Muffler with **double** tail pipe

120-204/07-2

## OPEL ASTRA F CLASSIC

combi

**04/96 -> 02**

1,4 60kW  
 1,4 16V 66kW  
 1,6i 52/55kW  
 1,6i 16V 74kW

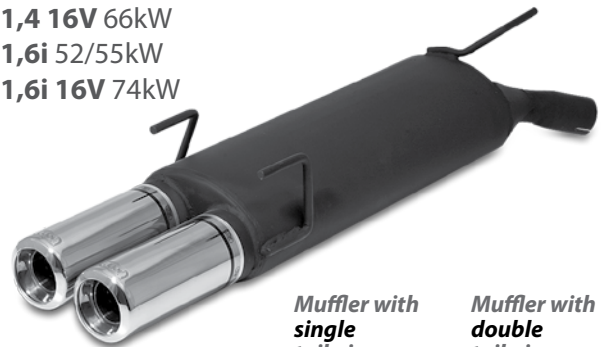

Muffler with **single** tail pipe

120-121/10

Muffler with **double** tail pipe

120-221/07-2

## OPEL ASTRA G

sedan

**98 -> 03**

1,4 16V 66kW  
 1,6 16V 74kW  
 1,8 8V 55/62kW  
 1,8 16V 85/92kW  
 2,0 16V 100kW  
 1,7 DTL 50kW  
 1,7 DTi 55kW  
 2,0 Di 60kW  
 2,0 DTi 74kW



Muffler with **single** tail pipe

120-106/10  
 120-106/21-1

Muffler with **double** tail pipe

120-206/07-2  
 120-206/12-1

## OPEL ASTRA G

*hatchback*

**98 -> 03**

1,4 16V 66kW  
 1,6 16V 74kW  
 1,8 8V 55/62kW  
 1,8 16V 85/92kW  
 2,0 16V 100kW  
 1,7 DTL 50kW  
 1,7 DTi 55kW  
 2,0 Di 60kW  
 2,0 DTi 74kW

**Muffler with  
single  
tail pipe**

120-105/10  
 120-105/21-1  
 120-105/28



**Muffler with  
double  
tail pipe**

120-205/07-2  
 120-205/12-1  
 120-205/45\*



**DUPLEX version**

**Muffler  
with two single  
tail pipes L+R**

120-305/21-1  
 120-305/28

**Muffler  
with two double  
tail pipes L+R**

120-405/07-2

## OPEL ASTRA G

*coupe, cabrio*

**98 -> 03**

1,6 16V 74/76kW  
 1,8 16V 85/92kW  
 2,2 16V 108kW

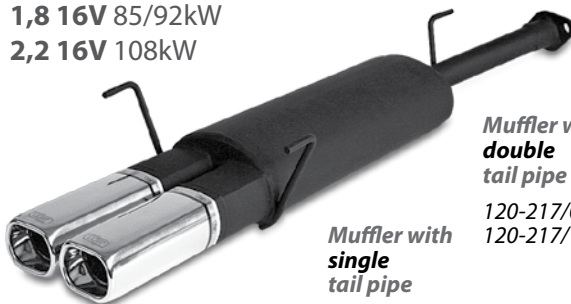

**Muffler with  
double  
tail pipe**

120-217/07-2  
 120-217/12-1

**Muffler with  
single  
tail pipe**

120-117/21-1  
 120-117/28

## OPEL ASTRA G

*coupe (assembly with clamping ring)*

**99 -> 03**

2,0 DTi 74kW  
 2,2 DTi 92kW



**Muffler with  
double  
tail pipe**

120-238/07-2  
 120-238/12-1

**Muffler with  
single  
tail pipe**

120-138/21-1  
 120-138/28

## OPEL ASTRA G

*combi*

**98 -> 03**

1,4 16V 66kW  
 1,6 16V 74kW  
 1,8 8V 55/62kW  
 1,8 16V 85/92kW  
 2,0 16V 100kW

**Muffler with  
single  
tail pipe**

120-116/10  
 120-116/21-1

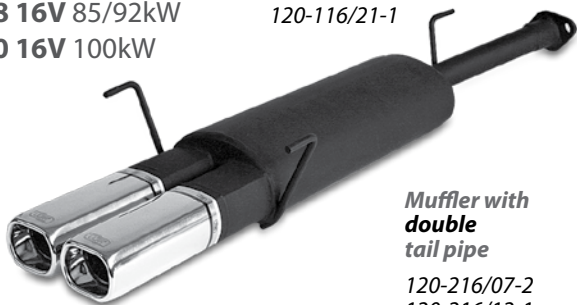

**Muffler with  
double  
tail pipe**

120-216/07-2  
 120-216/12-1

## OPEL ASTRA G

*coupe (flange connection)*

**01 -> 03**

2,0T 141/147kW  
 2,2 DTi 92kW  
 2,0 DTi 74kW



**Muffler with  
single  
tail pipe**

120-139/21-1  
 120-139/28

**Muffler with  
double  
tail pipe**

120-239/07-2  
 120-239/12-1

## OPEL ASTRA H

combi

04 -> 09

1,3CDTi 66kW  
1,7CDTi 59/74kW  
1,9CDTi 88/110kW

Muffler with  
single  
tail pipe

120-129/10-1  
120-129/21-1  
120-129/28



Muffler with  
double  
tail pipe

120-229/70RS  
120-229/10-1

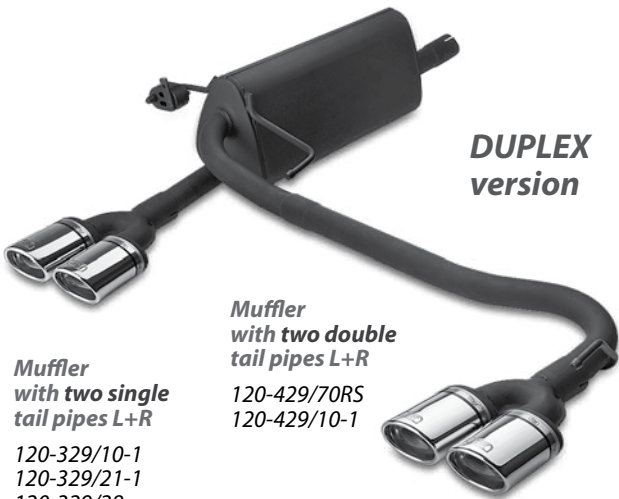

**DUPLEX**  
version

Muffler  
with two single  
tail pipes L+R

120-329/10-1  
120-329/21-1  
120-329/28

Muffler  
with two double  
tail pipes L+R

120-429/70RS  
120-429/10-1

## OPEL ASTRA H

combi

...continued



**DUPLEX** version

Muffler  
with two single  
tail pipes L+R

120-328/10-1  
120-328/21-1  
120-328/28

Muffler  
with two double  
tail pipes L+R

120-428/70RS  
120-428/10-1

## OPEL ASTRA H

hatchback 5D, GTC (without cutout in bumper)

04 -> 09

1,3CDTi 66kW  
1,7CDTi 59/74kW  
1,9CDTi 88/110kW

Muffler with  
single  
tail pipe

120-127/10-1  
120-127/21-1  
120-127/28



Muffler with  
double  
tail pipe

120-227/70RS  
120-227/10-1



**DUPLEX**  
version

Muffler  
with two single  
tail pipes L+R

120-327/10-1  
120-327/21-1  
120-327/28

## OPEL ASTRA H

combi

04 -> 09

1,4i 66kW  
1,6i 77kW  
1,8i 92kW

Muffler with  
single  
tail pipe

120-128/10-1  
120-128/21-1  
120-128/28



Muffler with  
double  
tail pipe

120-228/70RS  
120-228/10-1

## OPEL ASTRA H

hatchback 5D, GTC (without cutout in bumper)

04 -> 09

1,4i 66kW  
1,6i 77kW  
1,8i 92kW

Muffler with  
single  
tail pipe

120-123/10-1  
120-123/21-1  
120-123/28



Muffler with  
double  
tail pipe

120-223/70RS  
120-223/10-1



**DUPLEX version**

Muffler  
with two single  
tail pipes L+R

120-323/10-1  
120-323/21-1

## OPEL ASTRA H

hatchback 5D, GTC (with cutout in bumper)

04 -> 09

1,3CDTi 66kW  
1,7CDTi 59/74kW  
1,9CDTi 88/110kW

Muffler with  
single  
tail pipe

120-136/10-1  
120-136/27



## OPEL ASTRA H

hatchback 5D, GTC (with cutout in bumper)

04 ->

1,4i 66kW  
1,6i 77kW  
1,8i 92kW

Muffler with  
single  
tail pipe

120-137/10-1  
120-137/27



## OPEL ASTRA J

hatchback 5D

09 ->

1,6 T 132kW  
1,6 D 81kW

Muffler with  
single  
tail pipe

120-141/57  
120-141/27



**DUPLEX version**



Muffler  
with two single  
tail pipes L+R

120-341/57  
120-341/27

## OPEL CALIBRA

90 -> 07/97

2,0i 85kW 2WD, 4WD  
2,0 16V 110kW 4WD

Muffler with  
single  
tail pipe

120-119/21-1  
120-119/28



Muffler with  
double  
tail pipe

120-219/12-1  
120-219/13DTM

## OPEL CORSA B

**93 -> 01**

- 1,0 40kW
- 1,2 33kW
- 1,2 16V 48kW
- 1,4 44/60kW
- 1,4 16V 66kW
- 1,5TD 49kW
- 1,6 GSi 16V 78/80kW

*Muffler with  
single  
tail pipe*

120-108/10  
120-108/26



*Muffler with  
double  
tail pipe*

120-208/07-2

## OPEL KADETT E

*hatchback*

**84 -> 91**

- 1,3 44/55kW
- 1,4 44/55kW
- 1,6 55/60/66kW
- 1,8 62/66/74/82/85kW
- 2,0 GSi 85kW\*



*Muffler with  
single  
tail pipe*

120-107/10

*Muffler with  
double  
tail pipe*

120-207/07-2

\* available only for  
special order

## OPEL CORSA C

**01 -> 06**

- 1,0 12V 44kW
- 1,2 16V 59kW
- 1,4 16V 66kW
- 1,3CDTi 51kW
- 1,7DI 48/55kW
- 1,7CDTi 74kW
- 1,8GSi 92kW

*Muffler with  
single  
tail pipe*

120-109/10  
120-109/28



*Muffler with  
double  
tail pipe*

120-209/07-2  
120-209/12-1

## OPEL TIGRA A

**94 -> 00**

- 1,4i 16V 66kW
- 1,6i 16V 78kW



*Muffler with  
single  
tail pipe*

120-115/07-2  
120-115/10  
120-115/21-1

*Muffler with  
double  
tail pipe*

120-215/07-2

## OPEL CORSA D

**06 -> 14**

- 1,0 44kW
- 1,2 59kW
- 1,4 66kW



*Muffler with  
single  
tail pipe*

120-126/07-2  
120-126/10  
120-126/28\*

*Muffler with  
double  
tail pipe*

120-226/70RS\*

\* cutout in bumper necessary

## DUPLEX version



*Muffler  
with two single  
tail pipes L+R*

120-315/21-1

*Muffler  
with two double  
tail pipes L+R*

120-415/07-2

## OPEL VECTRA A

sedan

**88 -> 95**

1,4 55kW  
1,6 52/55/60kW  
1,8 66kW  
1,8GT 66kW  
2,0 85kW



Muffler with  
**single**  
tail pipe

120-110/10

Muffler with  
**double**  
tail pipe

120-210/07-2

## OPEL VECTRA A

hatchback

**88 -> 95**

1,4 55kW  
1,6 52/55/60kW  
1,8 66kW  
1,8GT 66kW  
2,0 85kW



Muffler with  
**single**  
tail pipe

120-111/10

Muffler with  
**double**  
tail pipe

120-211/07-2

## OPEL VECTRA B

hatchback, sedan

**09/95 -> 09/99**

1,6 16V 74kW  
1,8 16V 85kW  
2,0 16V 100kW



Muffler with  
**single**  
tail pipe

120-112/10  
120-112/21-1  
120-112/26

Muffler with  
**double**  
tail pipe

120-212/07-2  
120-212/12-1



### DUPLEX version

Muffler  
with two single  
tail pipes L+R

120-312/21-1

Muffler  
with two double  
tail pipes L+R

120-412/07-2

## OPEL VECTRA B

combi

**09/95 -> 09/99**

1,6 16V 74kW  
1,8 16V 85kW  
2,0 16V 100kW



Muffler with  
**single**  
tail pipe

120-113/10  
120-113/21-1  
120-113/26

Muffler with  
**double**  
tail pipe

120-213/07-2  
120-213/12-1

## OPEL VECTRA B facelifting

hatchback, sedan

**09/99 -> 09/02**

1,6 16V 74kW  
1,8 16V 92kW  
2,0 16V 100kW



Muffler with  
**single**  
tail pipe

120-114/10  
120-114/21-1  
120-114/26

Muffler with  
**double**  
tail pipe

120-214/07-2  
120-214/12-1

## OPEL VECTRA B facelifting

combi

09/99 -> 09/02

1,6 16V 74kW  
1,8 16V 92kW  
2,0 16V 100kW



Muffler with **single** tail pipe

120-131/10  
120-131/21-1  
120-131/26

Muffler with **double** tail pipe

120-231/07-2  
120-231/12-1

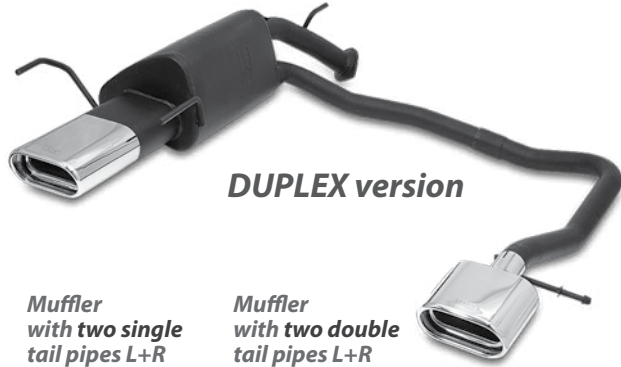

Muffler with two single tail pipes L+R

120-331/21-1

**DUPLEX version**

Muffler with two double tail pipes L+R

120-431/07-2

## OPEL VECTRA C

hatchback (with cutout in bumper)

09/02 -> 05

1,6 16V 74kW  
1,8 16V 81/90kW  
2,2 16V 108kW  
2,0 DTi 74kW  
2,2 DTi 86/92kW



Muffler with **single** tail pipe

120-125/10-1  
120-125/17-1  
120-125/27

**DUPLEX version \***



Muffler with two single tail pipes L+R

120-325/17-1  
120-325/27

\* cutout in bumper necessary

## OPEL VECTRA C

combi

## OPEL VECTRA C\*

sedan, hatchback (without cutout in bumper)

09/02 -> 05

1,6 16V 74kW  
1,8 16V 81/90kW  
2,2 16V 108kW  
2,0 DTi 74kW  
2,2 DTi 86/92kW



Muffler with **single** tail pipe

120-118/10-1  
120-118/28



**DUPLEX version \***

\* bumper trimming necessary

Muffler with two single tail pipes L+R

120-318/10-1  
120-318/28

03 -> 05

1,8 16V 90/103kW  
2,0T 16V 129kW  
1,9CDTi 74/88/110kW  
2,0DTi 74/92kW

Muffler with **single** tail pipe

120-122/28



Muffler with **double** tail pipe

120-222/10-1  
120-222/12-1

**DUPLEX version**

Muffler with two single tail pipes L+R

120-322/28

Muffler with two double tail pipes L+R

120-422/12-1

## OPEL VECTRA C

combi

03 -> 08

3,2 V6 155kW

*This set can be mounted also in models with engines: 1,8 2,0T 1,9CDTi 2,0DT*



Two mufflers with two single tail pipes L+R

120-330/28  
120-330/30

## OPEL ZAFIRA B

04 -> 10

1,6 77kW

1,8 103kW

1,9CDTi 74/88/110kW



Muffler with single tail pipe

120-124/28

Muffler with double tail pipe

120-224/10-1

## OPEL VECTRA C GTS

sedan, hatchback

03 -> 08

3,0 V6 CDTi 130kW

3,2 V6 155kW



Set of two mufflers L+R

120-342/57  
120-342/27

## OPEL OMEGA B

sedan

94 -> 00

2,0 85/100kW



Muffler with single tail pipe

120-133/21-1  
120-133/28

Muffler with double tail pipe

120-233/07-2  
120-233/12-1

## OPEL ZAFIRA

04/99 -> 03

1,6 16V 74/76kW

1,8 16V 85/92kW



Muffler with single tail pipe

120-120/10  
120-120/28

Muffler with double tail pipe

120-220/07-2

## OPEL OMEGA B

sedan

94 -> 00

2,5 V6 125kW

3,0 V6 155kW

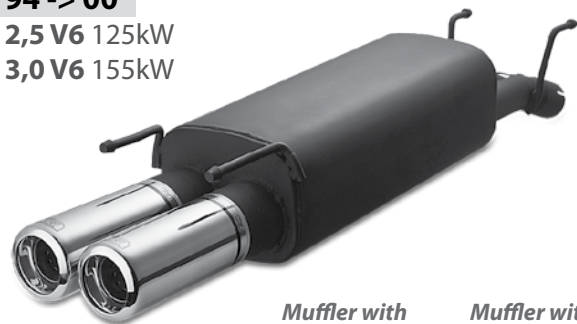

Muffler with single tail pipe

120-134/21-1

Muffler with double tail pipe

120-234/07-2  
120-234/12-1



## OPEL OMEGA B

combi

94 -> 00

2,5 V6 125kW  
3,0 V6 155kW

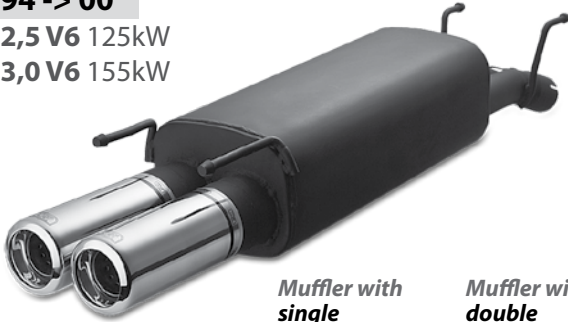

**Muffler with  
single  
tail pipe**

120-135/21-1  
120-135/50

**Muffler with  
double  
tail pipe**

120-235/07-2  
120-235/12-1  
120-235/90RS

## OPEL SIGNUM

03 -> 08

1,8 16V 90/103kW  
2,0 16V 129kW  
2,2 16V 144kW  
1,9 CDTi 88/110kW  
2,0 CDTi 74/85kW  
2,2 CDTi 92kW  
3,2 V6 155kW (duplex only)



**Muffler with  
single  
tail pipe**

120-132/21-1  
120-132/27

**Muffler with  
double  
tail pipe**

120-232/70RS  
120-232/12-1

**DUPLEX version**



**Two mufflers  
with two single  
tail pipes L+R**

120-332/21-1  
120-332/27

\* cutout in bumper necessary

**Two mufflers  
with two double  
tail pipes L+R**

120-432/70RS  
120-432/12-1

## OPEL INSIGNIA

sedan, hatchback 5d

08 -> 12

2,0 T 4x4 162kW  
2,0 CDTi (4x4) 118kW

**DUPLEX version**



**Set of 2 mufflers L+R**

120-345/27  
120-348/27 (FWD Version)

\* rear bumper lower required; tips without perforated inserts

**DUPLEX version**

**Factory version  
with 2 rear mufflers**



**Set of 2 mufflers L+R**

120-346/27

\* rear bumper lower required; tips without perforated inserts

## OPEL INSIGNIA

combi

08 -> 12

2,0 T 4x4 162kW  
2,0 CDTi (4x4) 118kW

**Factory version  
with 1 rear muffler**



**DUPLEX version**

**Set of 2 mufflers L+R**

120-343/27  
120-347/27 (FWD version)

\* rear bumper lower required; tips without perforated inserts

## OPEL INSIGNIA

combi

...continued

### DUPLEX version

Factory version  
with 2 rear mufflers



Set of two mufflers L+R;  
rear bumper lower required

120-344/27

\* rear bumper lower required; tips without perforated inserts

## PEUGEOT 206

hatchback

98 -> 03

1,1 44kW

1,4 55kW

1,6 65kW



Muffler with  
single  
tail pipe

121-102/07-2

121-102/10

121-102/17-1

121-102/22

121-102/26\*

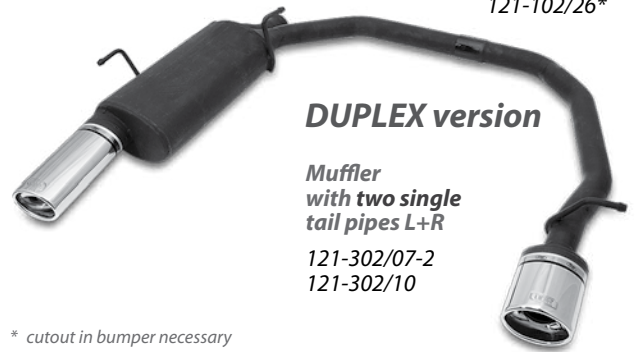

### DUPLEX version

Muffler  
with two single  
tail pipes L+R

121-302/07-2

121-302/10

\* cutout in bumper necessary

## PEUGEOT 106

09/91 -> 04/96

1,0 33kW

1,1 40kW

1,4 55kW

1,6 66kW



Muffler with  
single  
tail pipe

121-106/07-2

121-106/10

## PEUGEOT 206

hatchback

99 -> 08

2,0i 101kW



Muffler with  
single tail pipe

121-109/07-2

121-109/10

121-109/17-1

## PEUGEOT 106

96 -> 03

1,1 44kW

1,4 55kW

1,5D 40kW

1,6 66kW



Muffler with  
single  
tail pipe

121-101/07-2

121-101/10

121-101/26

## PEUGEOT 206

hatchback

03 -> 08

1,1 44kW

1,4 55kW

1,6 81kW



Muffler with  
single tail pipe

121-107/07-2

121-107/10

121-107/17-1

121-107/22

## PEUGEOT 206

*hatchback*

**98 -> 08**  
1,4 HDI 51kW



*Muffler with  
single  
tail pipe*

121-108/07-2  
121-108/10  
121-108/17-1

## PEUGEOT 206 RC

**02 -> 08**  
2,0i 16V 130kW



*Muffler with  
single  
tail pipe*

121-114/21-1

*Muffler with  
double  
tail pipe*

121-214/07-1

## PEUGEOT 206 CC

**00 -> 11**  
1,6 80kW



*Muffler with  
single  
tail pipe*

121-112/07-2  
121-112/10  
121-112/17-1

**DUPLEX version \***



*Muffler with two single  
tail pipes L+R*

121-312/07-2  
121-312/10  
121-312/17-1

\* cutout in bumper necessary

## PEUGEOT 207

*hatchback*

**06 -> 12**  
1,4 55/65kW



*Muffler with  
single  
tail pipe*

121-113/10-1

*Muffler with  
double  
tail pipe*

121-213/70RS

## PEUGEOT 207

*hatchback*

**06 -> 12**  
1,6 THP 115kW



*Muffler with  
single  
tail pipe*

121-116/10-1  
121-116/90RS

## PEUGEOT 207

*hatchback (cutout in bumper)*

**06 -> 12**

**1,6 HDI 60/80kW**



**Muffler with  
single  
tail pipe**

121-110/07-2  
121-110/10-1  
121-110/90RS

## PEUGEOT 307

*combi*

**01 -> 07**

**1,4 55kW  
1,6 80kW**



**Muffler with  
single  
tail pipe**

121-115/07-2  
121-115/17-1  
121-115/10-1

## PEUGEOT 306

*hatchback*

**94 -> 01**

**1,1i 44kW  
1,4i 55kW  
1,6i 66kW  
1,8i 74kW**



**Muffler with  
single  
tail pipe**

121-105/07-2  
121-105/17-1  
121-105/26

## PEUGEOT 406

*sedan, coupe*

**95 -> 04**

**2,0 16V 99/101kW**



**Muffler with  
single  
tail pipe**

121-111/07-2  
121-111/17-1

## PEUGEOT 307

*hatchback*

**01 -> 07**

**1,4 55kW  
1,6 80kW**



**Muffler with  
single  
tail pipe**

121-104/07-2  
121-104/10  
121-104/17-1

## PEUGEOT 406

*sedan*

**95 -> 03**

**1,6 65kW  
1,8 66kW  
1,8 16V 82kW**



**Muffler with  
single  
tail pipe**

121-103/07-2  
121-103/17-1

## PEUGEOT RCZ\*

10 -> 12

1,6 THP 115kW  
1,6 THP 147kW  
2,0 HDI 120kW

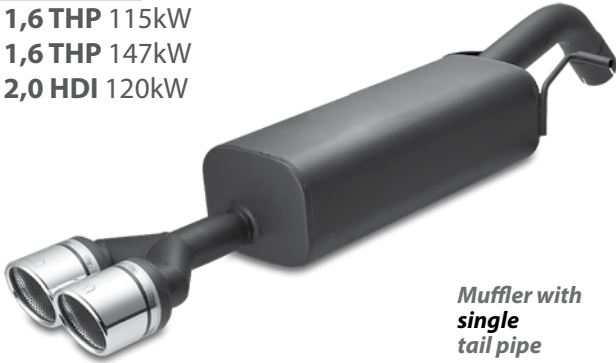

Muffler with  
**single**  
tail pipe  
121-217/90RS

\* cutout in bumper necessary

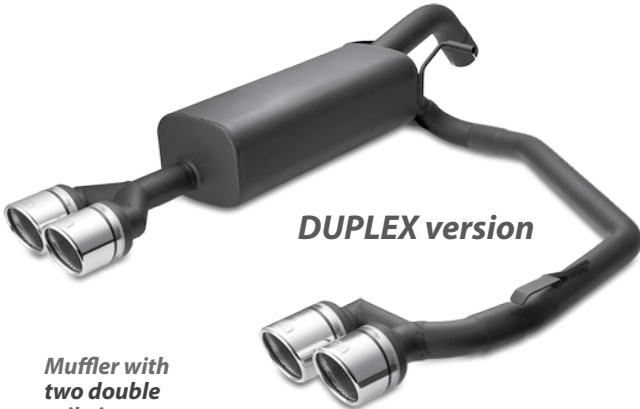

**DUPLEX version**

Muffler with  
**two double**  
tail pipes  
121-417/55  
121-417/90RS

\* cutout in bumper necessary

## RENAULT CLIO II

hatchback

00 -> 05

2,0i 124kW

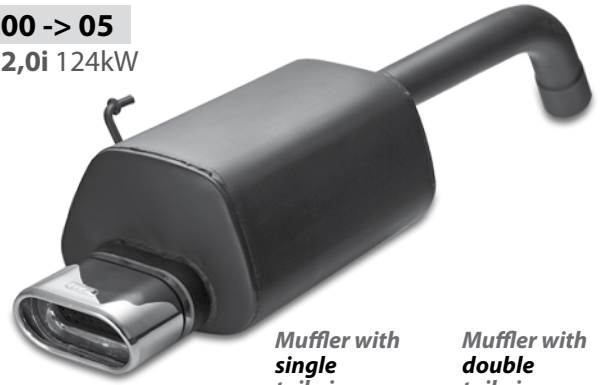

Muffler with  
**single**  
tail pipe

122-116/10  
122-116/21-1

Muffler with  
**double**  
tail pipe

122-216/07-2  
122-216/12-1

## RENAULT CLIO II SPORT

98 -> 05

2,0i

Set made of stainless steel  
with catalytic converter  
for rally version



Muffler with  
**single**  
tail pipe

122-103/R

## RENAULT CLIO II

98 -> 05

1,2 44kW  
1,4 55kW  
1,6 66kW



Muffler with  
**single**  
tail pipe

122-103/07-2  
122-103/10  
122-103/21-1

Muffler with  
**double**  
tail pipe

122-203/07-2  
122-203/12-1

## RENAULT CLIO III

hatchback

05 -> 12

1,1 55kW  
1,2 48/57,5/74kW  
1,4 72kW  
1,6 65/85kW  
1,5dCi 50/63/76/78kW

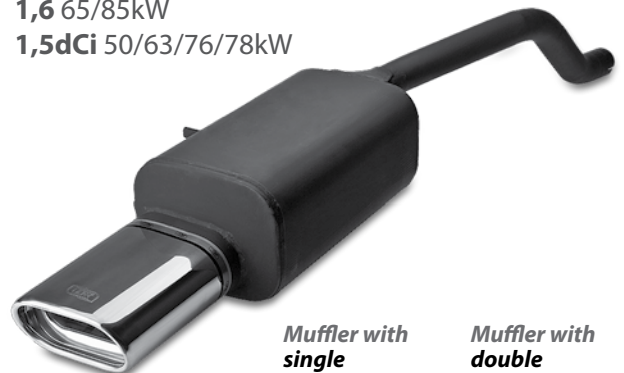

Muffler with  
**single**  
tail pipe

122-110/10  
122-110/21-1  
122-110/26

Muffler with  
**double**  
tail pipe

122-210/07-2  
122-210/12-1

## RENAULT CLIO III SPORT

05 -> 12

2,0i

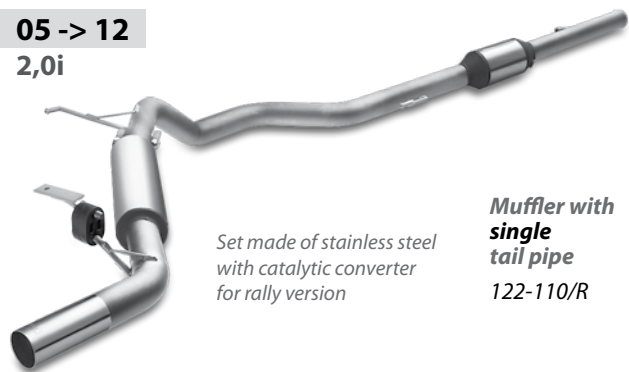

Set made of stainless steel with catalytic converter for rally version

**Muffler with single tail pipe**  
122-110/R

## RENAULT CLIO IV

5D

12 ->

0,9 66kW



**Muffler with double tail pipe**  
122-217/70RS

## RENAULT LAGUNA II

hatchback

02/01 -> 07

1,6 16V 81/85kW

1,8 16V 87kW

2,0 16V 99/103kW

1,9 dCi 70/74/81/85/88/92/96kW

2,2 dCi 102/110kW

**Muffler with single tail pipe**

122-111/10  
122-111/21-1  
122-111/28

**Muffler with double tail pipe**

122-211/07-2  
122-211/12-1

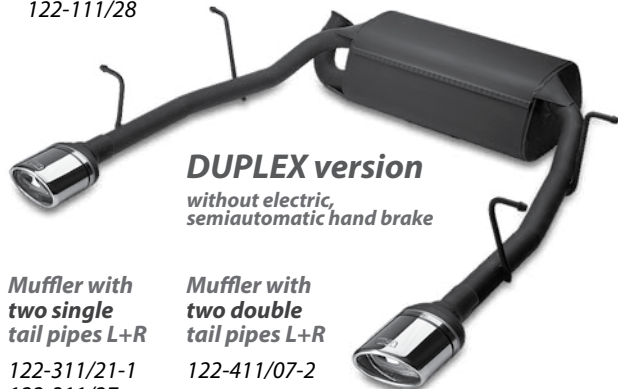

**DUPLEX version**  
without electric, semiautomatic hand brake

**Muffler with two single tail pipes L+R**  
122-311/21-1  
122-311/27

**Muffler with two double tail pipes L+R**  
122-411/07-2

## RENAULT LAGUNA III

grandtour

08 ->

2,0 dCi 96/110kW

**Muffler with single tail pipe**

122-112/21-1  
122-112/27

**Muffler with double tail pipe**

122-212/70RS  
122-212/07-2

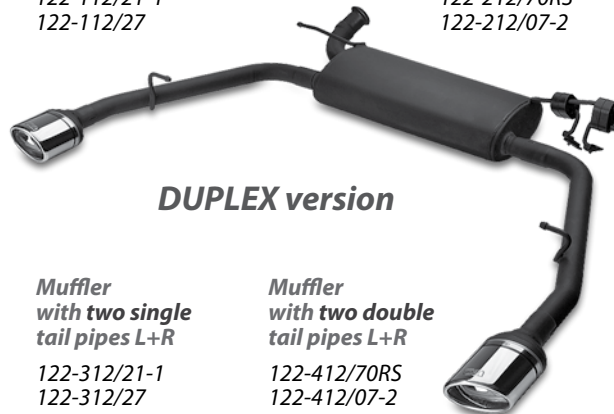

**DUPLEX version**

**Muffler with two single tail pipes L+R**

122-312/21-1  
122-312/27

**Muffler with two double tail pipes L+R**

122-412/70RS  
122-412/07-2

## RENAULT MEGANE

hatchback

99 -> 10/02

1,4 55kW

1,6 55/66kW

1,6 16V 79kW

1,8 16V 85kW

2,0 85kW



**Muffler with single tail pipe**

122-101/07-2  
122-101/10  
122-101/17-1



**DUPLEX version**

**Muffler with two single tail pipes L+R**

122-301/10  
122-301/17-1

\* additional cutout on the left side of a bumper next to the factory cutout is necessary

## RENAULT MEGANE

coupe, coach

**95 -> 10/02**

1,6 66kW  
1,6 16V 79kW  
2,0 85kW  
2,0 16V 108kW



**Muffler with single tail pipe**

122-102/07-2  
122-102/10  
122-102/17-1



**DUPLEX version \***

**Muffler with two single tail pipes L+R**

122-302/10  
122-302/17-1

\* cutout in bumper necessary

## RENAULT MEGANE CLASSIC

sedan

**95 -> 10/02**

1,4 55kW  
1,6 55/66kW  
1,6 16V 79kW  
1,8 16V 85kW  
2,0 85kW

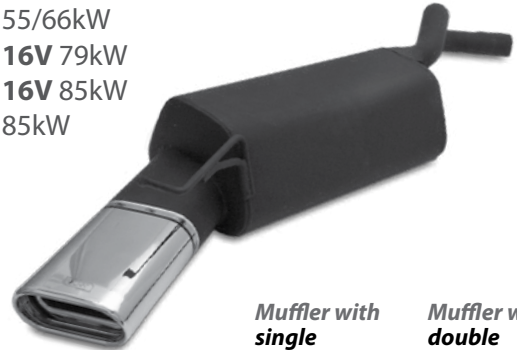

**Muffler with single tail pipe**

122-106/10  
122-106/21-1

**Muffler with double tail pipe**

122-206/07-2

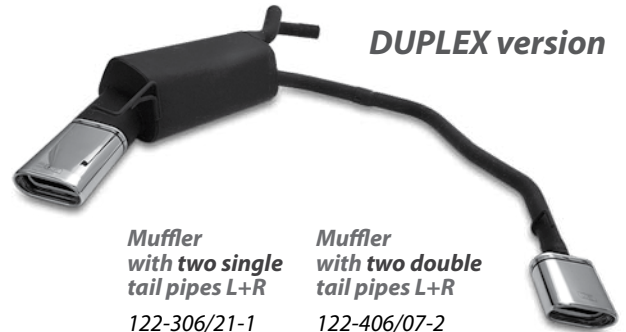

**DUPLEX version**

**Muffler with two single tail pipes L+R**

122-306/21-1

**Muffler with two double tail pipes L+R**

122-406/07-2

## RENAULT MEGANE SCENIC

**95 -> 10/02**

1,4 55kW  
1,6 55/66kW  
1,6 16V 79kW  
1,8 16V 85kW  
2,0 85kW



**Muffler with single tail pipe**

122-104/10  
122-104/21-1

**Muffler with double tail pipe**

122-204/12-1

## RENAULT MEGANE II

hatchback

**02 -> 07**

1,4 59/72/74kW  
1,6 16V 81/85kW  
1,5 dCi 59/74kW  
1,9 dCi 66/88kW



**Muffler with single tail pipe**

122-105/10  
122-105/21-1  
122-105/28

**Muffler with double tail pipe**

122-205/12-1

## RENAULT MEGANE II

combi

02 -> 07

1,4 59/72/74kW  
 1,6 16V 81/85kW  
 1,5 dCi 59/74kW  
 1,9 dCi 66/88kW

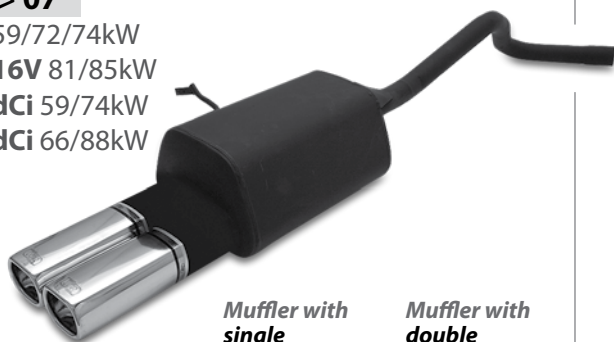

Muffler with  
**single**  
tail pipe

122-107/21-1

Muffler with  
**double**  
tail pipe

122-207/12-1

## RENAULT MEGANE III

hatchback 5D, coupe

...continued

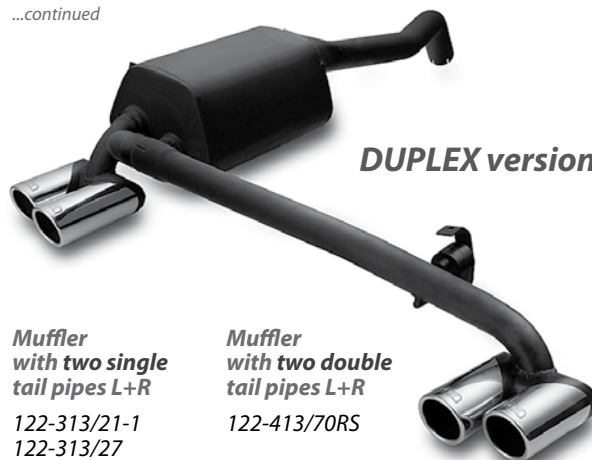

**DUPLEX version**

Muffler  
with two single  
tail pipes L+R

122-313/21-1  
 122-313/27

Muffler  
with two double  
tail pipes L+R

122-413/70RS

## RENAULT MEGANE III

grandtour, cabrio

08 -> 12

1,4 TCE 96kW  
 1,6 74/81kW  
 2,0 TCE 132kW  
 1,5 dCi 62/77kW  
 1,9 dCi 96kW  
 2,0 dCi 118kW



Muffler with  
**double**  
tail pipe

122-214/70RS  
 122-214/12-1

## SAAB 9-3

02->08

2,0i T 129kW



Muffler with  
**single**  
tail pipe

134-101/21-1  
 134-101/27

Muffler with  
**double**  
tail pipe

134-201/70RS

## RENAULT MEGANE III

hatchback 5D, coupe

08 -> 12

1,4 TCE 96kW  
 1,6 74/81kW  
 2,0 TCE 132kW  
 1,5 dCi 62/77kW  
 1,9 dCi 96kW  
 2,0 dCi 118kW



Muffler with  
**double**  
tail pipe

122-213/70RS  
 122-213/12-1

## SEAT ALTEA 5D

04 ->

1,4 64kW  
 1,6 75kW  
 2,0 FSI 110kW  
 1,9 TDi 77kW  
 2,0 TDi 100/103kW

Muffler with  
**single**  
tail pipe

124-108/21-1  
 124-108/27

Muffler with  
**double**  
tail pipe

124-208/70RS



\* not suitable for version XL, XXL



## SEAT IBIZA type 6K

02/93 -> 06/96

1,0 33kW  
1,3 40kW  
1,4 44kW  
1,6 55kW  
1,9D 47kW



Muffler with  
**single**  
tail pipe  
124-101/10  
124-101/17-1

## SEAT IBIZA type 6K

00 -> 02

1,0 37kW  
1,4 16V 55kW



Muffler with  
**single**  
tail pipe  
124-104/10  
124-104/21-1

Muffler with  
**double**  
tail pipe  
124-204/07-2

## SEAT IBIZA type 6K

06/96 -> 99

*transverse exhaust hangers*

1,6 55/74kW  
1,8 66kW  
1,9SDi 47kW  
1,9TDi 55/66kW



Muffler with  
**single**  
tail pipe

124-102/07-2

Muffler with  
**double**  
tail pipe

124-202/12-1

## SEAT IBIZA type 6L

03 -> 08

1,2 47kW  
1,4 55/63/74kW  
1,4 TDI 55kW  
1,9 SDI 47kW  
1,9 TDI 74/96kW



Muffler with  
**single**  
tail pipe

124-106/10  
124-106/21-1

Muffler with  
**double**  
tail pipe

124-206/70RS

## SEAT IBIZA type 6K

06/96 -> 99

*parallel exhaust hangers*

1,0 37kW  
1,4 44kW  
1,9D 47kW



Muffler with  
**single**  
tail pipe

124-103/10  
124-103/21-1

Muffler with  
**double**  
tail pipe

124-203/07-2

## SEAT LEON

99 -> 05

1,4 16V 55kW  
1,6 16V 74kW  
1,8 20V 92kW  
1,8T 132kW  
1,9 TDi 66/81/110kW



Muffler with  
**single**  
tail pipe

124-105/21-1  
124-105/28

Muffler with  
**double**  
tail pipe

124-205/70RS  
124-205/07-2  
124-205/12-1

## SEAT LEON II FR 200HP

05 -> 12

2,0 TFSi 147kW



**Muffler with  
single  
tail pipe**

124-110/21-1  
124-110/27

**Muffler with  
double  
tail pipe**

124-210/70RS

## SKODA 105, 120

76 -> 89

1,0 34kW

1,2 38kW

1,3 44kW



**Muffler with  
single  
tail pipe**

125-105/07-2  
125-105/10

## SEAT LEON II type P1, FR

05 -> 12

1,4 64kW

1,6 75kW

2,0 TDI 100/103/125kW



**Muffler with  
single  
tail pipe**

124-109/21-1  
124-109/27

**Muffler with  
double  
tail pipe**

124-209/70RS

## SKODA CITY GO

5D

11 ->

1,0 44/55kW

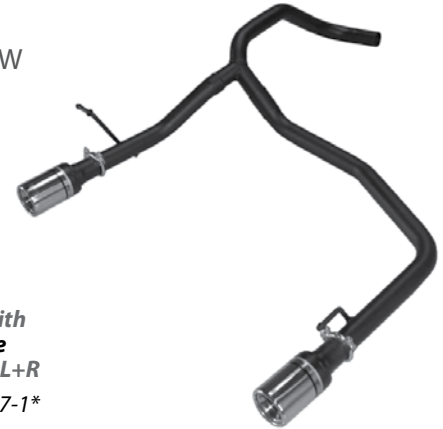

**Muffler with  
two single  
tail pipes L+R**

125-315/07-1\*

## SKODA FABIA I

sedan, combi

## SEAT TOLEDO type 1M\*

99 -> 04

1,9 SDi 50kW

1,9 TDi 66/81/96/110kW

1,4 55kW

1,6 74/77kW

1,8 20V 92kW

2,3 V5 110/125kW



**Muffler with  
single  
tail pipe**

124-107/21-1

**Muffler with  
double  
tail pipe**

124-207/70RS

\* cutout in bumper necessary

00 -> 06

1,2 40/47kW

1,4 44kW

1,4 16V 55/74kW

1,4 TDI 55kW

1,9 SDi 47kW

1,9 TDI 74/96kW

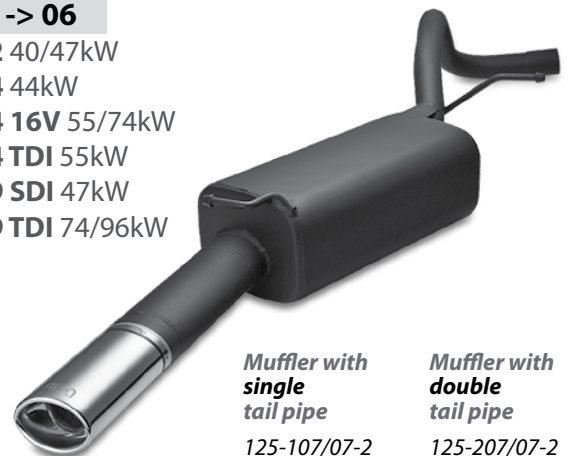

**Muffler with  
single  
tail pipe**

125-107/07-2  
125-107/10  
125-107/17-1  
125-107/21-1

**Muffler with  
double  
tail pipe**

125-207/07-2  
125-207/12-1  
125-207/13-1

## SKODA FABIA I

sedan, combi

...continued

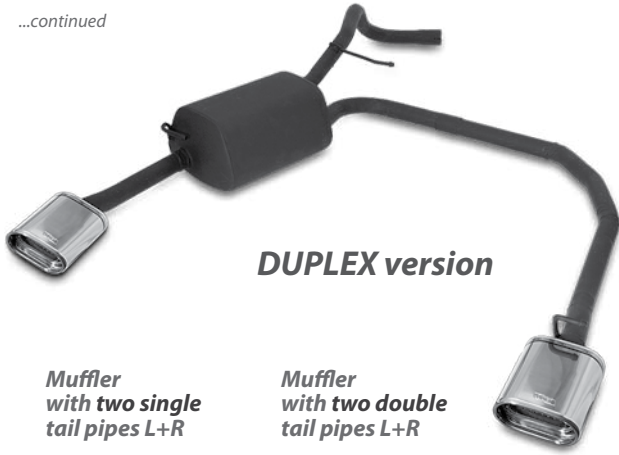

**DUPLEX version**

**Muffler with two single tail pipes L+R**  
125-307/21-1

**Muffler with two double tail pipes L+R**  
125-407/07-2

## SKODA FABIA II

hatchback

**06 -> 10**

1,2 44/51/55kW  
1,4 55/63kW  
1,6 77kW  
1,4 TDI 44/51/55/59kW  
1,9 TDI 77kW

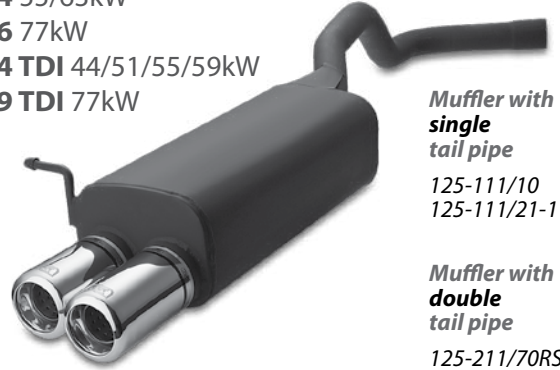

**Muffler with single tail pipe**

125-111/10  
125-111/21-1

**Muffler with double tail pipe**

125-211/70RS  
125-211/07-2

## SKODA FABIA I

hatchback

**00 -> 06**

1,0 37kW  
1,2 40/47kW  
1,4 44kW  
1,4 16V 55/74kW  
1,4 TDI 55kW  
1,9 SDI 47kW  
1,9 TDI 74/96kW

**Muffler with single tail pipe**

125-103/07-2  
125-103/10  
125-103/21-1  
125-103/21-1DTM



**Muffler with double tail pipe**

125-203/07-2  
125-203/13-1

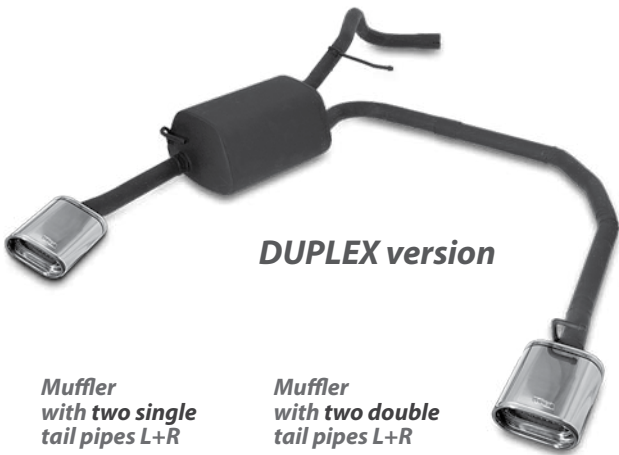

**DUPLEX version**

**Muffler with two single tail pipes L+R**  
125-303/21-1

**Muffler with two double tail pipes L+R**  
125-403/07-2

## SKODA FAVORIT

hatchback

**89 -> 10/94**

1,3 40/43/50kW

**Muffler with single tail pipe**

125-101/07-2  
125-101/10



## SKODA FELICIA

hatchback

**10/94 -> 01**

1,3 40/43/50kW  
1,6 55kW  
1,9SDi 47kW

**Muffler with single tail pipe**

125-102/07-2  
125-102/10  
125-102/21-1  
125-102/26



**Muffler with double tail pipe**

125-202/07-2  
125-202/12-1

## SKODA OCTAVIA I

combi, hatchback

**10/96 -> 04**

- 1,4 44/55kW
- 1,6 55/74kW
- 1,8 92kW
- 1,8T 110kW
- 1,9 SDI 50kW
- 1,9 TDI 66/81kW
- 1,9 TDI 74/96kW

**Muffler with single tail pipe**

125-104/10  
125-104/21-1



**Muffler with double tail pipe**

125-204/07-2  
125-204/10  
125-204/12-1  
125-204/90RS

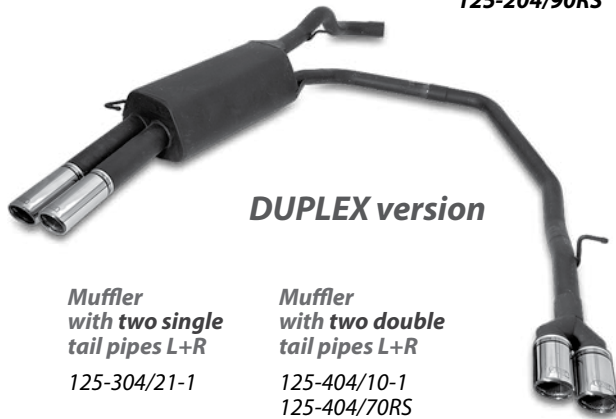

**DUPLEX version**

**Muffler with two single tail pipes L+R**  
125-304/21-1

**Muffler with two double tail pipes L+R**  
125-404/10-1  
125-404/70RS

## SKODA OCTAVIA II RS

combi, hatchback

**06 -> 13**

- 2,0 TFSI 147kW
- 2,0 TDI 125kW



**Muffler with single tail pipe**  
125-110/21-1

**Muffler with double tail pipe**  
125-210/70RS



**DUPLEX version**

**Two mufflers with two single tail pipes L+R**  
125-310/21-1

**Two mufflers with two double tail pipes L+R**  
125-410/70RS

## SKODA OCTAVIA I RS

combi, hatchback

**00 -> 04**

- 1,8T 132kW



**Muffler with double tail pipe**

125-204RS/07-2  
125-204RS/70RS

## SKODA OCTAVIA II

combi, hatchback

**04 -> 13**

- 1,6 75kW
- 1,6 FSI 85kW
- 2,0 FSI 110kW
- 1,9TDI 77kW
- 2,0TDI 103kW



**Muffler with single tail pipe**  
125-108/21-1  
125-108/28

**Muffler with double tail pipe**  
125-208/70RS

## SKODA OCTAVIA II SCOUT

**06 -> 13**

1,8 TSI 118kW  
2,0 TDI 103kW



Muffler with  
**single**  
tail pipe

125-113/21-1

Muffler with  
**double**  
tail pipe

125-213/70RS

### DUPLEX version



Two mufflers  
with two double  
tail pipes L+R  
125-413/70RS

Two mufflers  
with two single  
tail pipes L+R  
125-313/21-1

## SKODA SUPERB I

sedan

**02 -> 08**

1,8T 110kW  
2,0 85kW  
1,9TDi 74/96kW

Muffler with  
**single**  
tail pipe

125-106/21-1

Muffler with  
**double**  
tail pipe

125-206/70RS  
125-206/07-2

### DUPLEX version

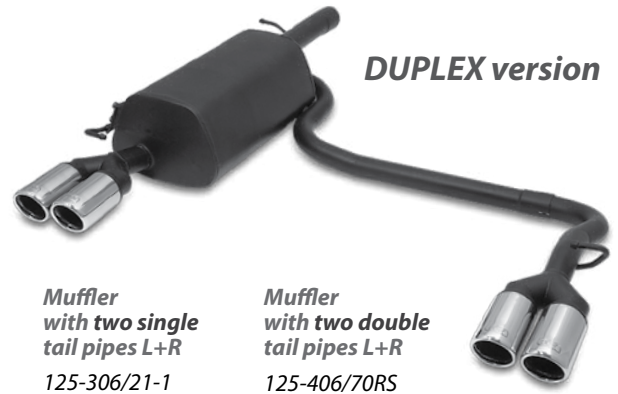

Muffler  
with two single  
tail pipes L+R  
125-306/21-1

Muffler  
with two double  
tail pipes L+R  
125-406/70RS

## SKODA OCTAVIA III type 5E

combi

**12 ->**

1,4 TSi 103kW



Muffler with  
**double** tail pipe  
125-216/70RS

## SKODA ROOMSTER

**06 -> 10**

1,2 47/51kW  
1,4 55/63kW  
1,6 75/77kW  
1,4 TDI 51/59kW  
1,9 TDI 77kW

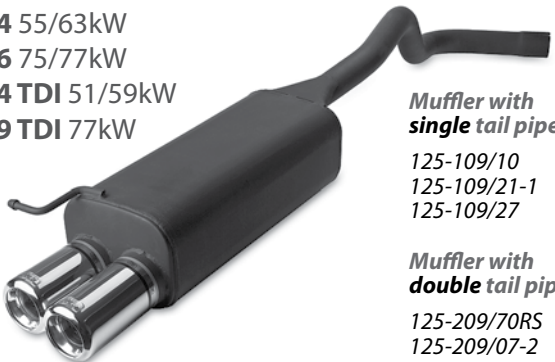

Muffler with  
**single** tail pipe  
125-109/10  
125-109/21-1  
125-109/27

Muffler with  
**double** tail pipe  
125-209/70RS  
125-209/07-2

## SKODA SUPERB II

sedan

**08 ->**

1,4 TSi 92kW  
1,8 TSi 118kW  
1,9 TDI 77kW  
2,0 TDI 103/125kW

Muffler with  
**single**  
tail pipe  
125-112/21-1



Muffler with  
**double**  
tail pipe  
125-212/70RS

### DUPLEX version

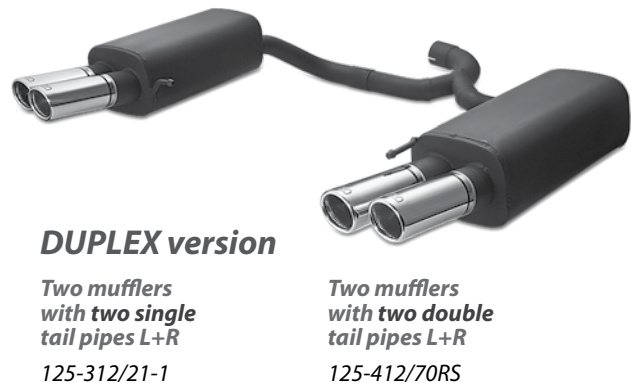

Two mufflers  
with two single  
tail pipes L+R  
125-312/21-1

Two mufflers  
with two double  
tail pipes L+R  
125-412/70RS

## SKODA YETI\*

09 -> 12

1,2 TSI 77kW  
1,4 TSI 89kW  
1,6 TDI 77kW  
2,0 TDI 80kW



Muffer with  
**single**  
tail pipe

125-114/21-1

Muffer with  
**double**  
tail pipe

125-214/70RS

\* only FWD version

## SUBARU IMPREZA I gen.

94 -> 00

1,6i 66kW  
1,8i 76kW  
2,0i 85kW



Muffer with  
**single**  
tail pipe

126-103/10  
126-103/21-1  
126-103/26

Muffer with  
**double**  
tail pipe

126-203/70RS

## SUBARU IMPREZA GT

94 -> 00

2,0T 160kW



Muffer with  
**single**  
tail pipe

126-107/16-1  
126-107/90RS

## SUBARU FORESTER I, II

98 -> 08

2,0 90/92kW/116kW  
2,0 T 125kW  
2,5 T 154kW



Muffer with  
**single**  
tail pipe

126-106/16-1  
126-106/90RS

## SUBARU IMPREZA WRX

sedan, wagon

00 -> 08

2,0 160kW



Muffer with  
**single**  
tail pipe

126-101/16-1  
126-101/101RS

## SUBARU FORESTER III gen.

08 ->

2,0 TD 108kW



Two mufflers with  
**two single**  
tail pipes L+R

126-302/17-1  
126-302/27

## SUBARU IMPREZA WRX, STi

sedan

**00 -> 08**  
2,0 160kW



*stainless steel rear muffler*  
NRS 126-101/16-1

*Pipe connecting catalytic converter with end muffler*

NRS 126-101/SR (STi ONLY)

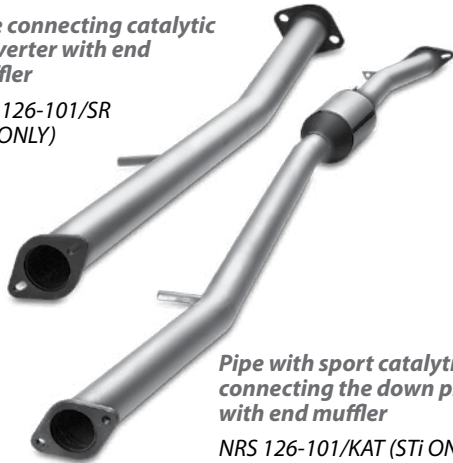

*Pipe with sport catalytic converter connecting the down pipe with end muffler*  
NRS 126-101/KAT (STi ONLY)

## SUZUKI SWIFT II, III gen.

hatchback

**89 -> 05**  
1,0 37/39/41kW  
1,3 47/50/52/54kW



*Muffler with single tail pipe*  
127-101/10

*Muffler with double tail pipe*  
127-201/07-2

## SUZUKI SWIFT II, III gen.

sedan

**89 -> 05**  
1,0 37/39/41kW  
1,3 47/50/52/54kW



*Muffler with single tail pipe*  
127-102/07-2

*Muffler with double tail pipe*  
127-202/07-2

## SUBARU IMPREZA WRX, STi III gen.

hatchback

**07 ->**  
2,5T 220kW



*Muffler with two double tail pipes*  
126-404/90RS  
126-404/101RS

## SUBARU LEGACY III

combi

**98 -> 03**  
2,5i 115kW



*Muffler with single tail pipe*  
126-105/10  
126-105/16-1  
126-105/26

## SUZUKI SWIFT

**10 ->**  
1,2 69kW



*Muffler with double tail pipe*  
127-208/70RS

## SUZUKI SWIFT SPORT (92kW)

06 -> 10

1,6 92kW



**Muffler with  
two single  
tail pipes**

127-306/101RS

## SUZUKI GRAND VITARA

3 door version

05 -> 12

1,6 16V 78kW

1,9 Diesel 95kW



**Muffler  
with two single  
tail pipes L+R**

127-304/21-1

## SUZUKI SWIFT SPORT (100kW)

12 ->

1,6 16V 100kW



**Muffler with  
two single  
tail pipes**

127-307/101RS

## SUZUKI GRAND VITARA II

5D 4x4

09 -> 14

2,4 124kW



**Muffler with  
single  
tail pipe**

127-109/27

## SUZUKI SX4

06 -> 12

1,6i 79/89kW



**Muffler with  
single  
tail pipe**

127-105/07-2  
127-105/10-1  
127-105/70RS  
127-105/90RS

## TOYOTA AURIS

07 -> 12

1,4 VVTi 71/74kW

1,6 VVTi 91/97kW

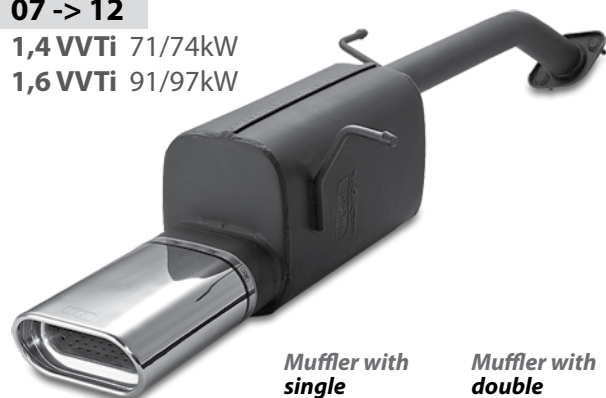

**Muffler with  
single  
tail pipe**

128-112/10-1  
128-112/21-1

**Muffler with  
double  
tail pipe**

128-212/70RS



## TOYOTA AURIS II

10/2012 ->

1,6 97kW



Muffler with **single tail pipe**  
128-114/27

## TOYOTA CELICA T-SPORT T23

00-> 06

1,8 VVTL-i 141kW

Muffler with **single tail pipe**  
128-110/17-1

**DUPLEX version \***



Muffler with **two single tail pipes L+R**  
128-310/17-1

\* cutout in bumper necessary

## TOYOTA AVENSIS III

combi

12 ->

2,0 91kW diesel

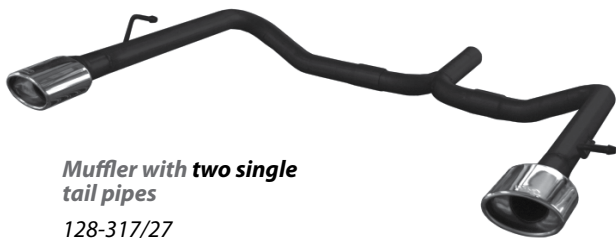

Muffler with **two single tail pipes**  
128-317/27

## TOYOTA CELICA T23

99 -> 06

1,8 VVT-i 105kW

Muffler with **single tail pipe**  
128-108/17-1

**DUPLEX version \***



Muffler with **two single tail pipes L+R**  
128-308/17-1

\* cutout in bumper necessary

## TOYOTA AYGO

05 -> 11

1,0 50kW



Muffler with **two single tail pipes**  
128-318/70RS

## TOYOTA COROLLA type E10

hatchback

05/92 -> 04/97

1,3 16V 55/65kW

1,6 16V 84kW

Muffler with **single tail pipe**  
128-105/10  
128-105/16-1



Muffler with **double tail pipe**  
128-205/07-2  
128-205/13DTM

## TOYOTA COROLLA type E11

*hatchback*

**97 -> 01**

1,3 63kW

1,4 71kW

1,6 81kW



**Muffler with  
single  
tail pipe**

128-101/10  
128-101/17-1  
128-101/26

**Muffler with  
double  
tail pipe**

128-201/07-2  
128-201/13DTM

## TOYOTA COROLLA TS

*hatchback*

**02 -> 07**

1,8 141kW



**Muffler with  
single  
tail pipe**

128-116/90RS

## TOYOTA COROLLA type E11

*sedan*

**04/97 -> 01**

1,4 71kW

1,6 81kW



**Muffler with  
single  
tail pipe**

128-106/10  
128-106/26

**Muffler with  
double  
tail pipe**

128-206/07-2

## TOYOTA COROLLA type E12

*hatchback*

**11/01 -> 04**

1,4 16V 71kW

1,6 16V 81kW



**Muffler with  
single  
tail pipe**

128-104/21-1  
128-104/26

**Muffler with  
double  
tail pipes**

128-204/12-1  
128-204/70RS

## TOYOTA IQ

**09 ->**

1,0 50kW



**Muffler with  
single  
tail pipe**

128-109/07-2  
128-109/10

**Muffler with  
double  
tail pipe**

128-209/70RS

### DUPLEX version



**Muffler  
with two single  
tail pipes L+R**

128-309/07-2  
128-309/10

**Muffler  
with two double  
tail pipes L+R**

128-409/70RS

## TOYOTA LAND CRUISER IV

**05 -> 12**  
3,0 D-4D 122kW

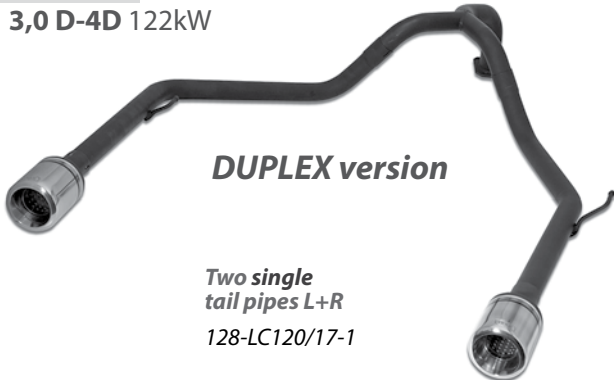

**DUPLEX version**

**Two single tail pipes L+R**

128-LC120/17-1

*\* Duplex set for the version with / without rear tube bumper, for the version with a spare wheel on the tailgate*

## TOYOTA RAV4 4WD

4x4

**12 ->**  
2,2 D4D 110kW



**Muffler with two single tail pipes L+R**

128-315/07-2\*

## TOYOTA RAV4

**94 -> 00**  
2,0 16V 94kW



**Muffler with single tail pipe**

128-303/07-2  
128-303/17-1

*not suitable for version with towing bar*

## TOYOTA YARIS

**99 -> 05**  
1,0 50kW  
1,3 64kW



**Muffler with single tail pipe**

128-102/10  
128-102/26

**Muffler with double tail pipe**

128-202/07-2

## TOYOTA RAV4 type XA3\*

**05 -> 12**  
2,0 VVT-i 112kW  
2,2 D-4D 100kW  
2,2 D-4D 130kW

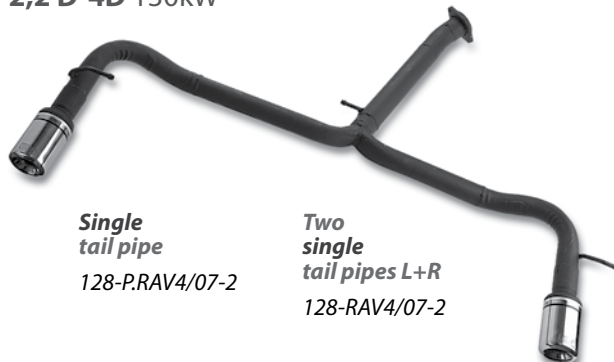

**Single tail pipe**

128-P.RAV4/07-2

**Two single tail pipes L+R**

128-RAV4/07-2

*\* Duplex set (without muffler) for the version with / without a spare wheel on the tailgate*

## TOYOTA YARIS II

**07 -> 11**  
1,3i 74kW



**Muffler with single tail pipe**

128-113/10  
128-113/28

**Muffler with double tail pipe**

128-213/70RS

## TOYOTA YARIS III 5D

5 door

**11 ->**

1,0 51kW

1,3 73kW

1,5 55kW/4800 Hybrid

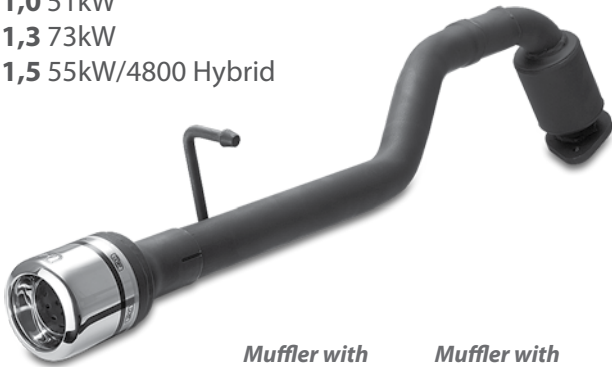

*Muffler with  
single  
tail pipe*

128-111/10  
128-111/26

*Muffler with  
double  
tail pipe*

128-211/70RS

**DUPLEX version**



*Muffler  
with two single  
tail pipes L+R*

128-311/10  
128-311/26

## VOLKSWAGEN GOLF II

**85 -> 92**

1,8 GTi 16V 95/102kW



*Muffler with  
double  
tail pipe*

129-202/07-2

## VOLKSWAGEN GOLF II

**85 -> 92**

1,8 66/69kW

1,8 GTi 82kW



*Muffler with  
single  
tail pipe*

129-101/07-2

*Muffler with  
double  
tail pipe*

129-201/07-2

## VOLKSWAGEN GOLF III

hatchback

## VOLKSWAGEN BORA, GOLF IV 5D

Bora sedan & combi, Golf IV combi

**99 -> 04**

1,9 SDi 50kW

1,9 TDi 66/74/81/85/96/110kW

1,4 55kW

1,6 74/75/77kW

1,8 20V 92kW

1,8T 110kW

2,0 85kW



*Muffler with  
single  
tail pipe*

129-108/21-1

*Muffler with  
double  
tail pipe*

129-208/07-2

**93 -> 97**

1,6 74kW

1,8 66kW

2,0 85kW

2,0 GTi 85kW

1,9D 48kW z kat.

1,9SDi 47kW

1,9TD 55kW

1,9TDi 66kW

*Muffler with  
single  
tail pipe*

129-103/10

129-103/21-1



*Muffler with  
double  
tail pipe*

129-203/07-2

129-203/12-1

## VOLKSWAGEN GOLF III

*hatchback*

**11/91 -> 12/97**

*version with long inlet pipe*

**1,9D** 48kW bez kat.

**1,4** 44kW

**1,6** 55kW

**1,8** 55kW



**Muffler with single tail pipe**

129-112/10  
129-112/21-1

**Muffler with double tail pipe**

129-212/07-2  
129-212/12-1

## VOLKSWAGEN GOLF V\*

*hatchback*

**03 -> 08**

**1,4** 55kW

**1,4 FSI** 66kW

**1,6** 75kW

**1,6 FSI** 85kW

**2,0 FSI** 110kW

**1,9 TDI** 66/77kW

**2,0 TDI** 100/103kW

**2,0 SDI** 55kW

**Muffler with single tail pipe**

129-110/21-1  
129-110/27

**Muffler with double tail pipe**

129-210/70RS  
129-210/10-1  
129-210/90RS



**DUPLEX version**

**Muffler with two single tail pipes L+R**

129-310/21-1  
129-310/27

**Muffler with two double tail pipes L+R**

129-410/70RS  
129-410/10-1

\* cutout in bumper necessary

## VOLKSWAGEN GOLF IV\*

*hatchback*

**10/97 -> 06/04**

**1,9 SDi** 50kW

**1,9 TDi** 66/74/81/85/96/110kW

**1,4** 55kW

**1,6** 74/75/77kW

**1,8 20V** 92kW

**1,8T** 110kW

**2,0** 85kW

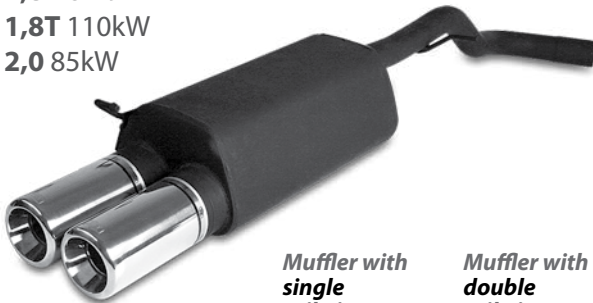

**Muffler with single tail pipe**

129-104/07-2  
129-104/10  
129-104/21-1

**Muffler with double tail pipe**

129-204/07-2  
129-204/10  
129-204/12-1  
129-204/70RS

\* left inner fender trimming necessary

**DUPLEX version**



**Muffler with two single tail pipes L+R**

129-304/17-1 \*\*  
129-304/21-1

**Muffler with two double tail pipes L+R**

129-404/07-2

\*\* cutout in bumper necessary

## VOLKSWAGEN GOLF V R32 LOOK

**03 -> 08**

**1,4i** 55kW

**1,4 FSI** 66kW

**1,6i** 75kW

**1,6 FSI** 85kW

**2,0 FSI** 110kW

**1,9 TDI** 66/77kW

**2,0 TDI** 100/103kW

**2,0 SDI** 55kW

**With rear bumper from R32 version only**

**DUPLEX version**

**Muffler with two single tail pipes L+R**

129-319/101RS



## VW GOLF V GTI

*hatchback*

**04 -> 08**

**2,0 147kW**



**Muffler with double tail pipe**

129-221/70RS

## VOLKSWAGEN GOLF VI GTI LOOK

**09 -> 11**

**1,4 59kW**

**1,4 TSI 90/118kW**

**2,0 TDi 81/103kW**

*With rear bumper from GTI version only*

**DUPLEX version**



**Muffler with two single tail pipes L+R**

129-320/90RS

## VOLKSWAGEN GOLF VI

*hatchback*

**09 -> 11**

**1,4 59kW**

**1,4 TSI 90/118kW**

**2,0 TDi 81/103kW**



**tail pipe**

129-118/90RS  
129-118/21-1  
129-118/70RS  
129-118/27

**Muffler with double tail pipe**

129-218/70RS

## VW GOLF VII GTI

*hatchback*

**12 ->**

**2,0 169kW**



**Muffler with two single tail pipes L+R**

129-322/101RS

## VW GOLF VII R

*hatchback*

**12 ->**

**2,0 206/221kW**



**Muffler with two double tail pipes L+R**

129-424/90RS

**DUPLEX version**

**Muffler with two single tail pipes L+R**

129-318/21-1  
129-318/27  
129-318/90RS

**Muffler with two double tail pipes L+R**

129-418/70RS

## VOLKSWAGEN JETTA V

05 ->

1,6 75kW  
1,6 FSI 85kW  
2,0 FSI 110kW  
1,9 TDi 77kW  
2,0 TDi 103kW



*Muffler with  
single  
tail pipe*

129-114/10  
129-114/21-1  
129-114/28

*Muffler with  
double  
tail pipe*

129-214/70RS

## VOLKSWAGEN PASSAT B5 type 3B

sedan, combi

96 -> 05

1,6 74kW  
1,8 20V 92kW  
1,8T 110kW  
1,9 TDi 66/81/85kW



*Muffler with  
single  
tail pipe*

129-107/21-1  
129-107/28

*Muffler with  
double  
tail pipe*

129-207/70RS  
129-207/07-2  
129-207/10

## VOLKSWAGEN LUPO

10/98 -> 05

1,4i 16V 55kW



*Muffler with  
single  
tail pipe*

129-113/10-1  
129-113/28

*Muffler with  
double  
tail pipe*

129-213/70RS



**DUPLEX version**

*Muffler  
with two single  
tail pipes L+R*

129-307/21-1

*Muffler  
with two double  
tail pipes L+R*

129-407/70RS

## VOLKSWAGEN NEW BEETLE

98 -> 10

1,8T 110kW  
1,9TDI 75kW  
1,4 55kW  
1,6 75kW  
2,0 85kW



*Muffler with  
single  
tail pipe*

129-111/10  
129-111/26

*Muffler with  
double  
tail pipe*

129-211/07-2  
129-211/70RS

## VOLKSWAGEN PASSAT type 3C (B6,B7\*)

sedan, combi

05->10 (B6), 10 -> 14 (B7)

1,6 75kW  
1,6 FSI 85kW  
1,8 118kW  
2,0 FSI 110kW  
1,9 TDI 77/103kW  
2,0 TDI 103/125kW  
2,0 TSI 155kW (B7)

*Muffler with  
single  
tail pipe*

129-115/10-1  
129-115/21-1  
129-115/27



*Muffler with  
double  
tail pipe*

129-215/70RS

## VOLKSWAGEN POLO type 6N

*hatchback*

**95 -> 01**

1,0 33/37kW  
 1,3 44kW  
 1,4 40/44/55kW  
 1,6 55kW  
 1,9D 47kW



**Muffler with single tail pipe**

129-105/07-2  
 129-105/10  
 129-105/21-1

**Muffler with double tail pipe**

129-205/07-2  
 129-205/12-1

## VOLKSWAGEN SCIROCCO III

**08 -> 13**

1,4 TSI 90/118kW  
 2,0TDi 103kW



**Muffler with single tail pipe**

129-116/21-1  
 129-116/27

**Muffler with double tail pipe**

129-216/70RS

**DUPLEX version**



**Muffler with two single tail pipes L+R**

129-316/21-1  
 129-316/27

**Muffler with two double tail pipes L+R**

129-416/70RS

*\* DUPLEX version cutout in bumper necessary*

## VOLKSWAGEN T4

*transporter, caravelle, multivan*

**92 -> 03**

2,0 62kW  
 2,5 81kW  
 2,8VR6 103kW  
 2,4D 57kW  
 2,5 TDi 65/75/111kW



**DUPLEX version**

**Three mufflers with two single tail pipes L+R**

129-306/21-1

**Three mufflers with two double tail pipes L+R**

129-406/07-2

## VOLKSWAGEN TOURAN

**03->10**

1,4 103/110/125kW  
 1,6 75/85kW  
 2,0 80/110kW  
 1,9 TDI 66/74kW  
 2,0 TDi 100/103/125kW



**Muffler with single tail pipe**

129-117/21-1  
 129-117/27

**Muffler with double tail pipe**

129-217/70RS

**DUPLEX version**

**Muffler with two single tail pipes L+R**

129-317/21-1  
 129-317/27

**Muffler with two double tail pipes L+R**

129-417/70RS



## VOLKSWAGEN VENTO

11/91 -> 04/98

1,4 44kW  
1,6 74kW  
1,8 66kW  
2,0 85kW  
1,9D 48kW z kat.  
1,9TD 55kW



*Muffler with  
double  
tail pipe*

129-209/07-2

*Muffler with  
single  
tail pipe*

129-109/21-1

## VOLVO V50

04 -> 12

2,0 TD



*DUPLEX set without muffler  
with tail pipes L+R*

130-V50/27

## VOLVO S40/V40

01 -> 04

1,9 TD 75/85kW



*Muffler with  
single  
tail pipe*

130-101/21-1  
130-101/27

*Muffler with  
double  
tail pipe*

130-201/70RS

## VOLVO S60

00 -> 09

2,0i T 132kW

2,3i T 184kW

2,4i 103/125kW

2,4i T 147/191kW

2,5i T 154kW

2,4 TD 93/96/120/136kW



*Muffler with  
single  
tail pipe*

130-102/17-2  
130-102/33  
130-102/90RS

## VOLVO V40 II

*hatchback*

12 ->

1,6 110kW



*Muffler with  
two single  
tail pipes L+R*

130-303/90RS

# EXHAUST EMBELLISHERS

exhaust embellishers dedicated to specific car models



**N17-2 ML**  
MERCEDES ML W163 (Ø100)



**N28 ML**  
MERCEDES ML W163 (120x80)



**NX90.1**  
MITSUBISHI LANCER 2007 1,8 (Ø90)  
**NX90.2**  
MITSUBISHI LANCER 2007 1,5 (Ø90)



**NX70.1**  
FORD FOCUS II HB (Ø70)  
**NX70.2**  
TOYOTA AYGO (Ø70)



**NX70.4**  
FORD KA II



**NX10.10**  
OPEL ASTRA H (95x65)



**NX17-1.3**  
TOYOTA LAND CRUISER J200  
4,5 V8 (Ø100)



**NX17-1.4**  
SUBARU FORESTER 2008  
(Ø100)



**NX27.3**  
SUBARU FORESTER 2008  
(120x80)

# TAIL PIPES DEDICATED TO SPECIFIC CAR MODELS

## MERCEDES VITO



**VITO N21-1**  
MERCEDES VITO 96-03 (145x75)

## FORD FOCUS II



**NX2-07-2**  
FORD FOCUS II HB (2xØ80)



**NX2-70RS**  
FORD FOCUS II HB (2xØ70)

## SMART



**SMART N10**  
SMART FORTWO (95x65)



**SMART 2xN53**  
SMART FORTWO



**SMART 2x60 (with perforated insert)**  
**SMART 60 (without perforated insert)**  
SMART FORTWO

**SMART ROADSTER**  
SMART ROADSTER



**SMART II 2x60**  
SMART FORTWO II

## RENAULT MEGANE II



**NX21-1**  
RENAULT MEGANE II  
1,4i; 1,6i; 1,5 dCi 59kW (145x75)



# EXHAUST EMBELLISHERS DEDICATED TO SPECIFIC CAR MODELS

**AUDI Q7**



NX17-1.2 (Ø100)



NX27.1 (120x80)

**BMW X5**



NX90.3 (Ø90)

**MERCEDES ML W164**

*Only for versions without the factory fitted embellishers*



NX33.4 (105x80)

**MERCEDES E-CLASS W211**



NX28.2 (120x80)

**PORSCHE CAYENNE**

NX2-55.1 (220x80)



NX33.3 (105x80)

**RANGE ROVER 2008**

3,6 TD V8 Sport



# EXHAUST EMBELLISHERS DEDICATED TO SPECIFIC CAR MODELS



## RANGE ROVER 2008

3,6 TD V8 Autobiography

**NX17-1.1** (Ø100)  
**NX21-1.4** (145x75)  
**NX24-1.1** (100x75)  
**NX28.1** (120x80)



## VW TOUAREG I

**NX2-70RS.1** (4xØ70) assembly with clamping ring (inlet Ø70)



**NX21-1.3** for welding on (inlet Ø60)



**NX21-1.3.1** (145x75) assembly with clamping ring (inlet Ø70)



**NX33.1** for welding on (inlet Ø60)



**NX33.2** (105x80) assembly with clamping ring (inlet Ø70)



**NX2-101/90** (2xØ100/90)

## VW TOUAREG II



# UNIVERSAL MUFFLERS (STAINLESS STEEL / ALUMINIUM PLATED STEEL)

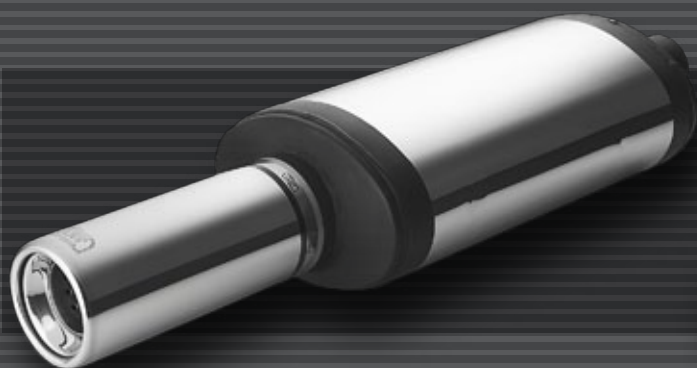

**NRS142/07 (Ø80)**  
**NM-142/07**

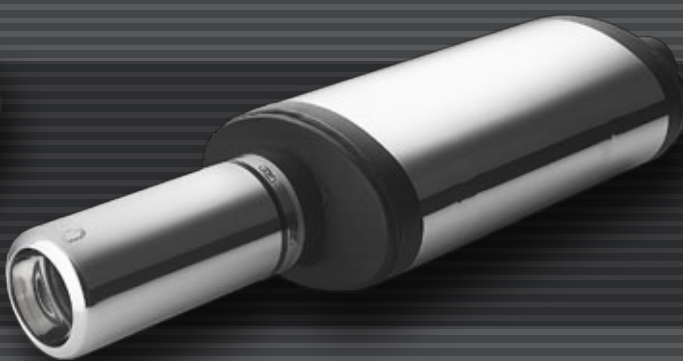

**NRS142/07-1 (Ø80)**  
**NM-142/07-1**

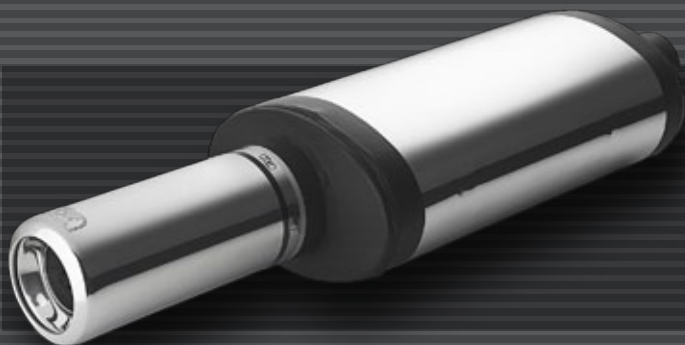

**NRS142/07-2 (Ø80)**  
**NM-142/07-2**

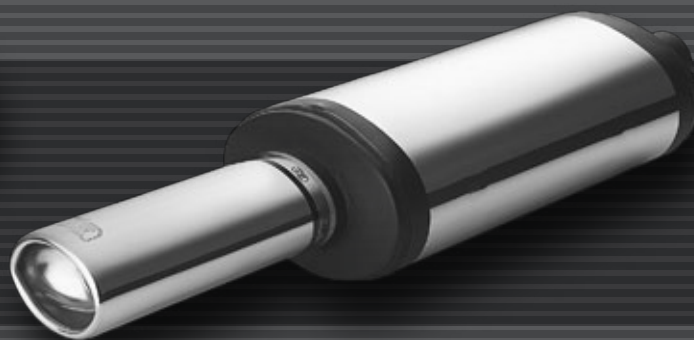

**NRS142/10 (95x65)**  
**NM-142/10**

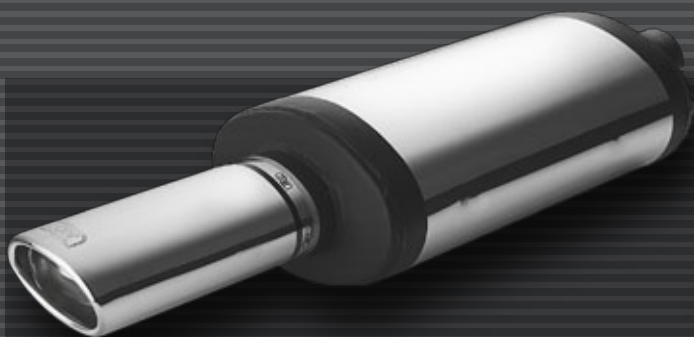

**NRS142/10-1 (95x65)**  
**NM-142/10-1**

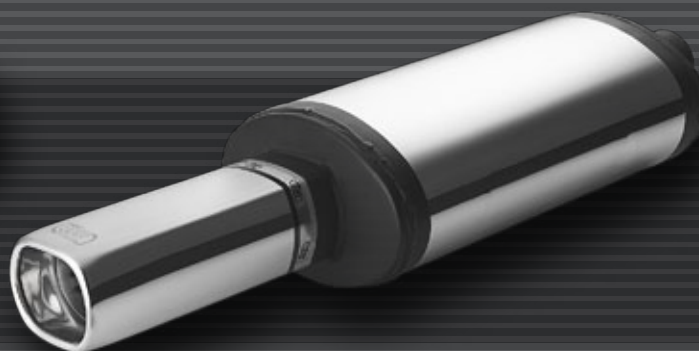

**NRS142/12-1 (80x65)**  
**NM-142/12-1**

# UNIVERSAL MUFFLERS (STAINLESS STEEL / ALUMINIUM PLATED STEEL)

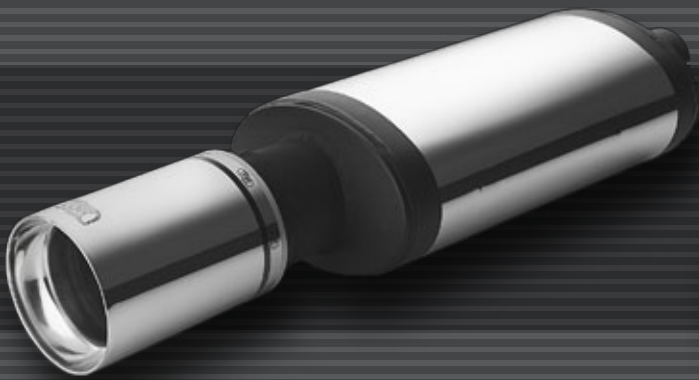

NRS142/16 (Ø100)  
NM-142/16

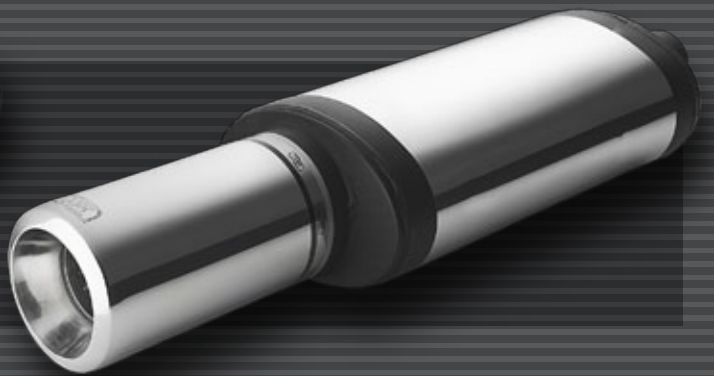

NRS142/17-1 (Ø100)  
NM-142/17-1

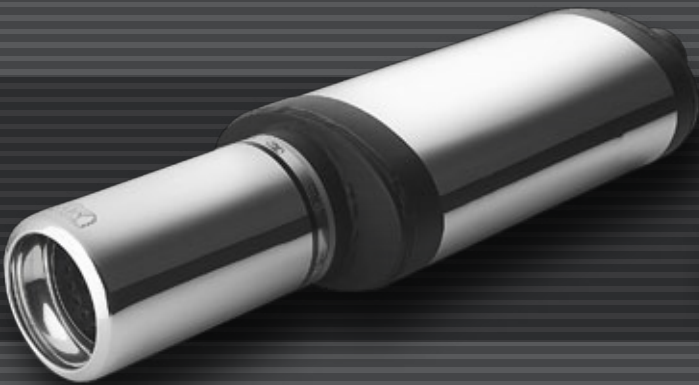

NRS142/17-2 (Ø100)  
NM-142/17-2

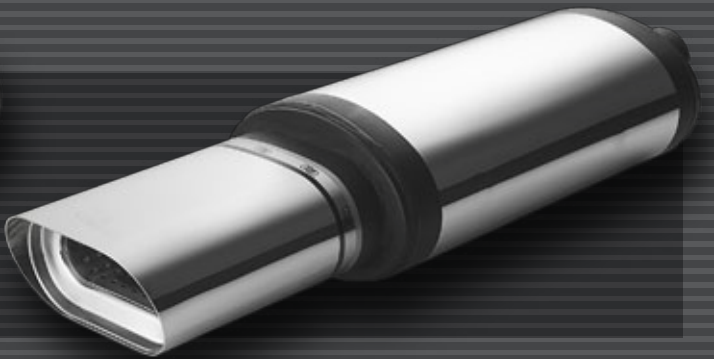

NRS142/21 (145x75)  
NM-142/21

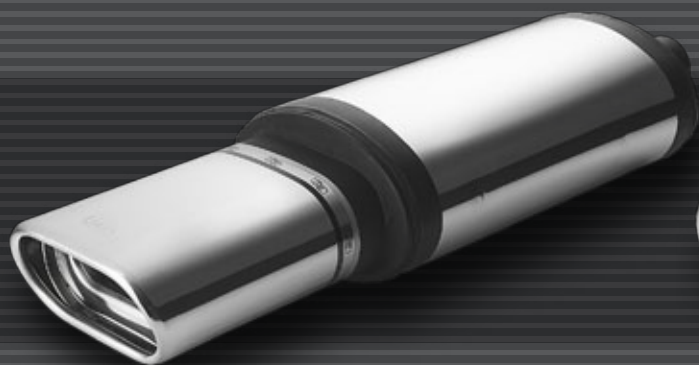

NRS142/21-1 (145x75)  
NM-142/21-1

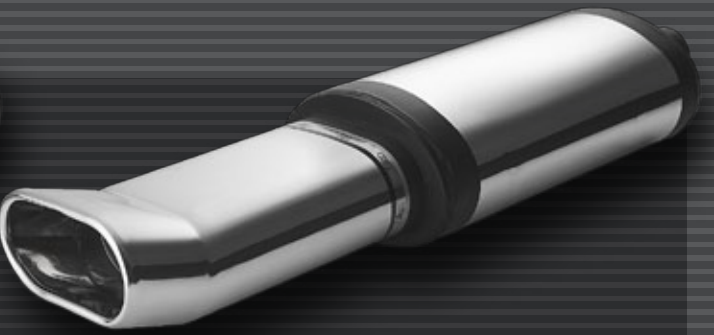

NRS142/21-1DTM (145x75)  
NM-142/21-1DTM



# UNIVERSAL MUFFLERS (STAINLESS STEEL / ALUMINIUM PLATED STEEL)

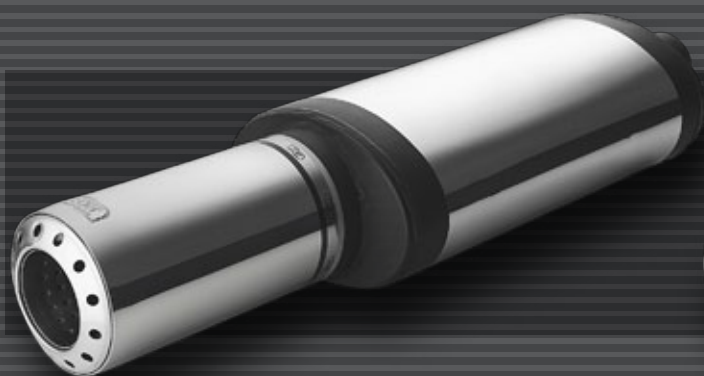

**NRS142/22** (Ø100)  
**NM-142/22**

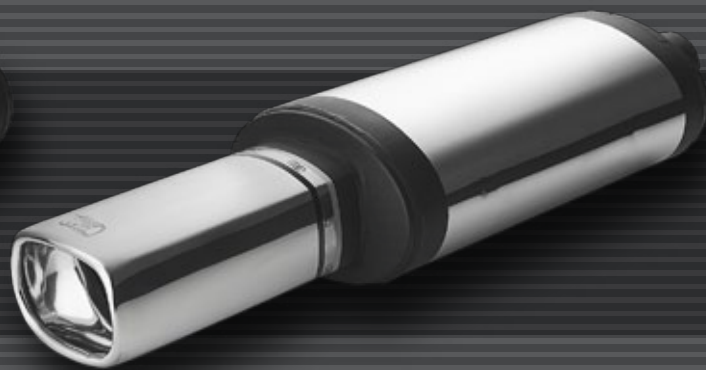

**NRS142/24** (100x75)  
**NM-142/24**

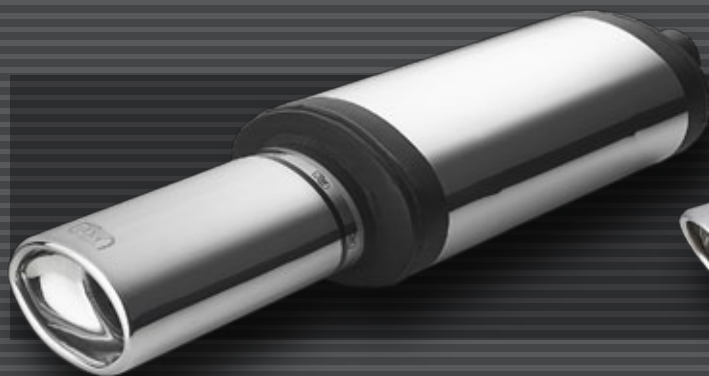

**NRS142/26** (120x80)  
**NM-142/26**



**NRS142/27 L** (120x80)  
**NRS142/27 R** (120x80)  
**NM-142/27 L**  
**NM-142/27 R**

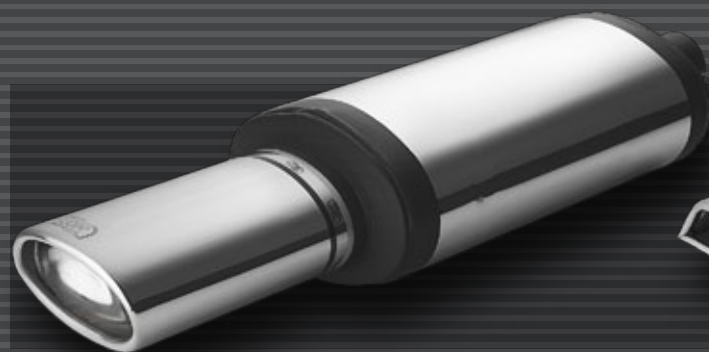

**NRS142/28** (120x80)  
**NM-142/28**

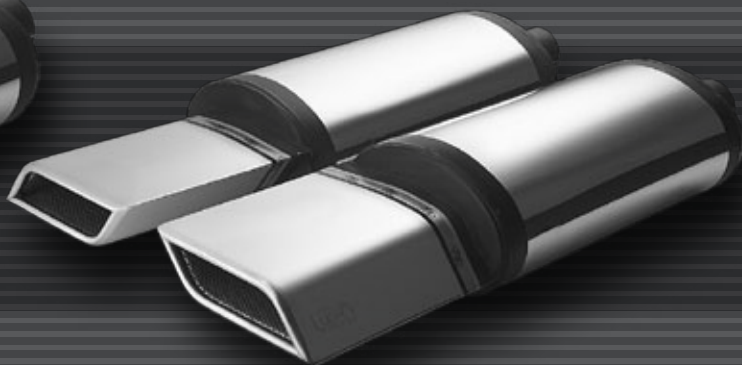

**NRS142/30 L** (170x55)  
**NRS142/30 R** (170x55)  
**NM-142/30 L**  
**NM-142/30 R**



# UNIVERSAL MUFFLERS (STAINLESS STEEL / ALUMINIUM PLATED STEEL)

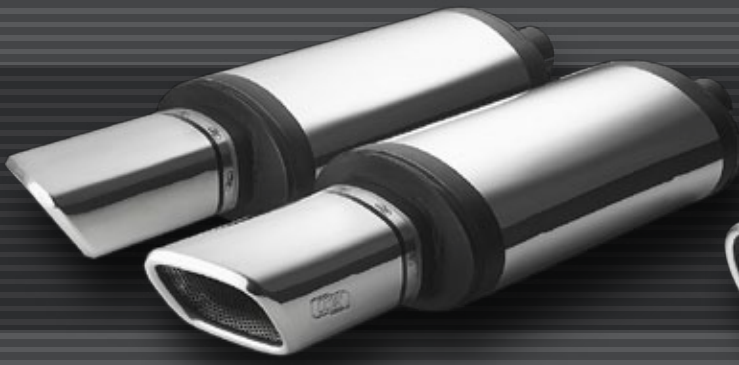

**NRS142/33 L** (105x80)  
**NRS142/33 R** (105x80)  
**NM-142/33 L**  
**NM-142/33 R**

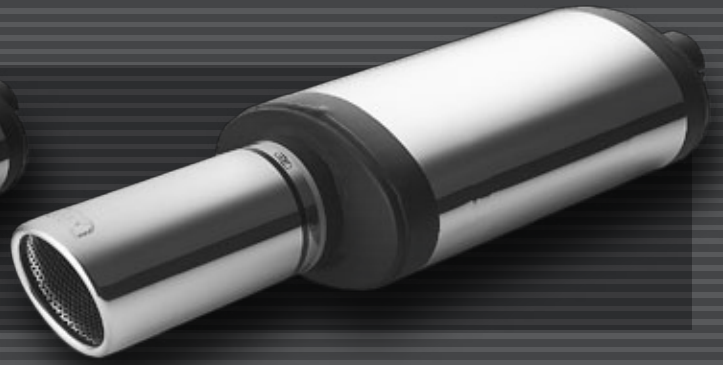

**NRS142/70RS** (Ø70)  
**NM-142/70RS**

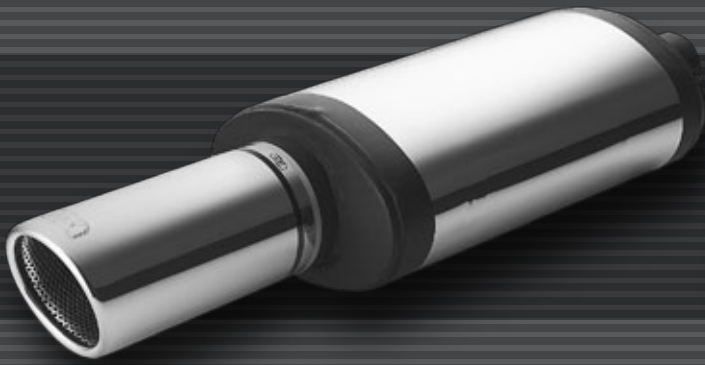

**NRS142/90RS** (Ø90)  
**NM-142/90RS**

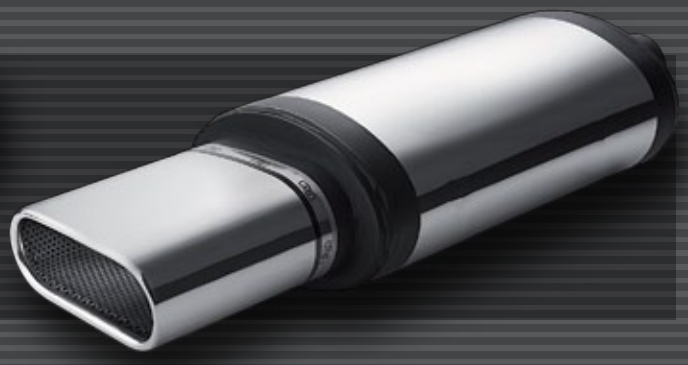

**NRS142/50** (167x60)  
**NM-142/50**

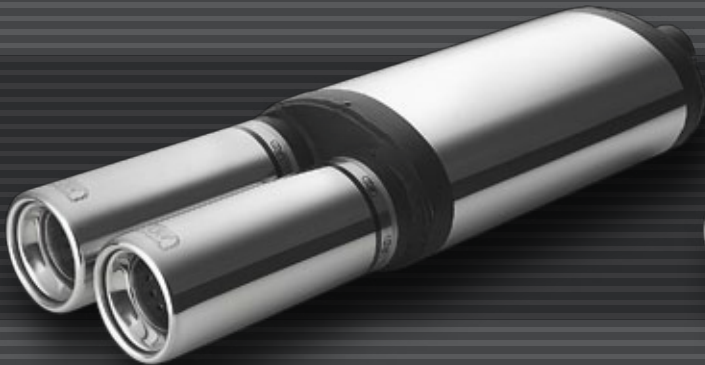

**NRS242/07** (2xØ80)  
**NM-242/07**

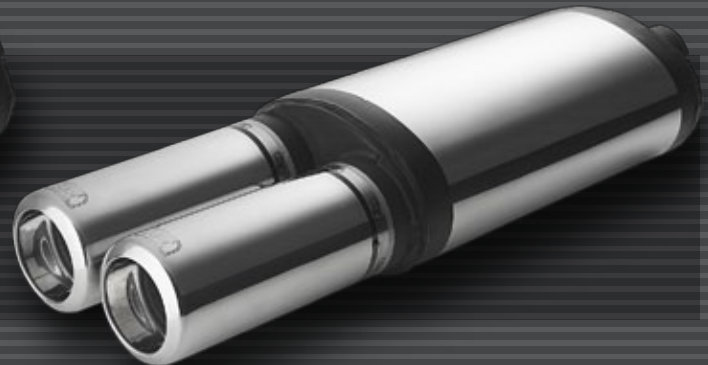

**NRS242/07-1** (2xØ80)  
**NM-242/07-1**



# UNIVERSAL MUFFLERS (STAINLESS STEEL / ALUMINIUM PLATED STEEL)

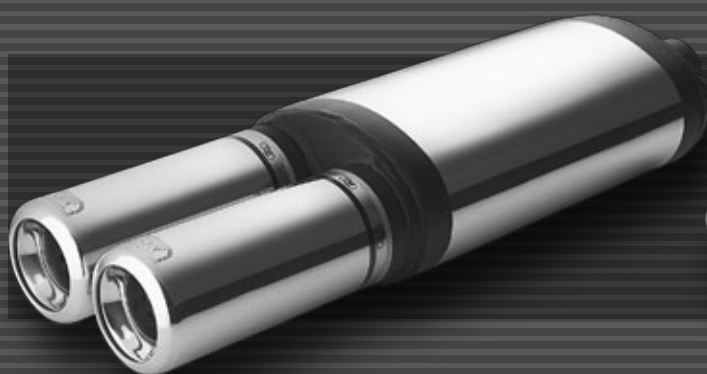

**NRS242/07-2** (2xØ80)  
**NM-242/07-2**

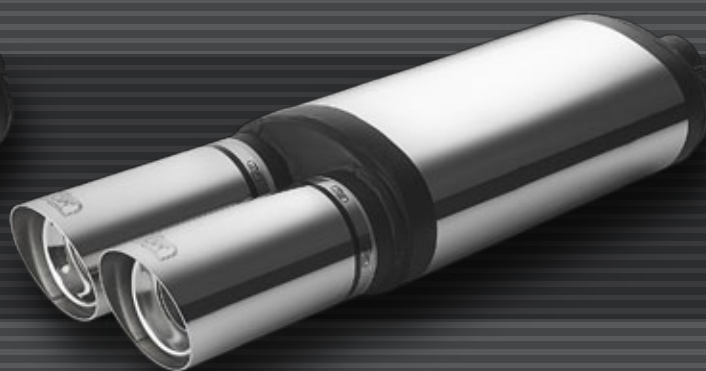

**NRS242/08-1** (2xØ80)  
**NM-242/08-1**

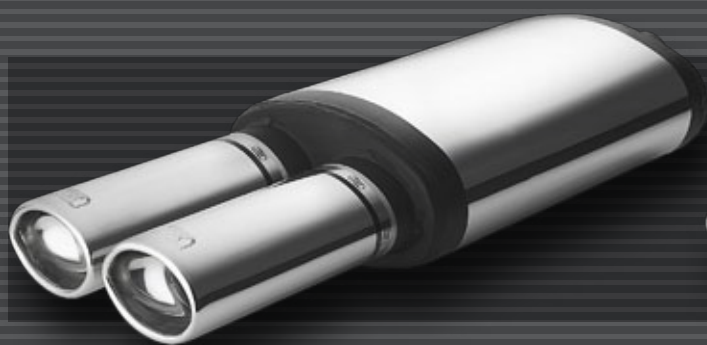

**NRS242/10** (2x95x65)  
**NM-242/10**

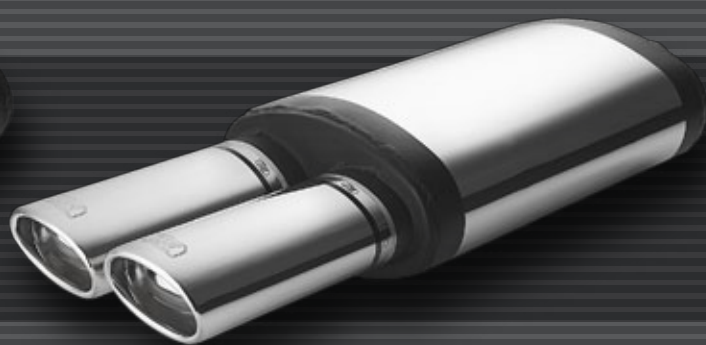

**NRS242/10-1** (2x95x65)  
**NM-242/10-1**

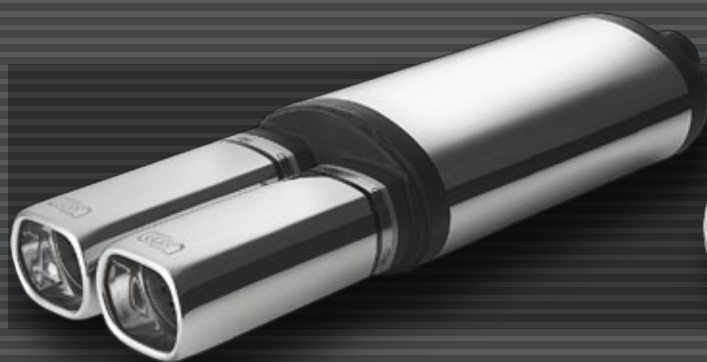

**NRS242/12-1** (2x80x65)  
**NM-242/12-1**

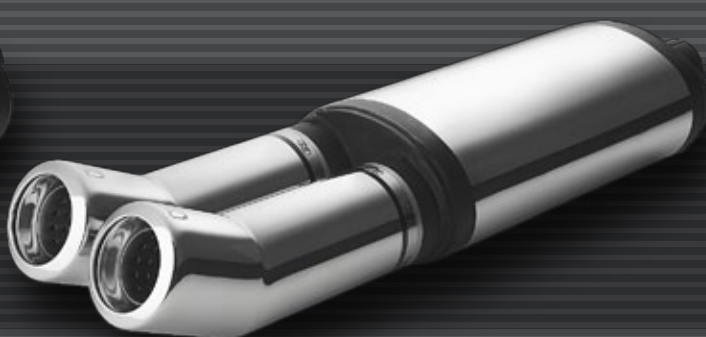

**NRS242/13-1** (2xØ80)  
**NM-242/13-1**

# UNIVERSAL MUFFLERS (STAINLESS STEEL / ALUMINIUM PLATED STEEL)

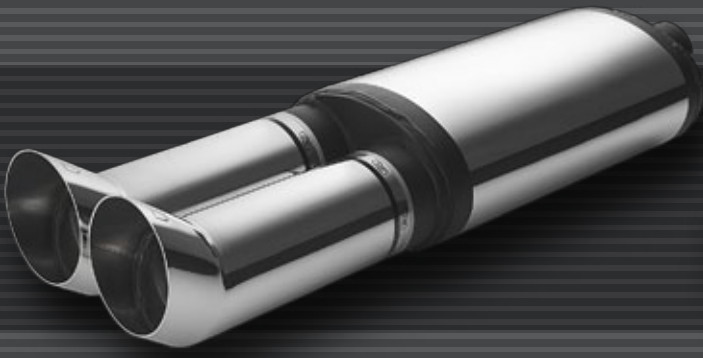

**NRS242/13DTM** (2xØ80)  
**NM-242/13DTM**

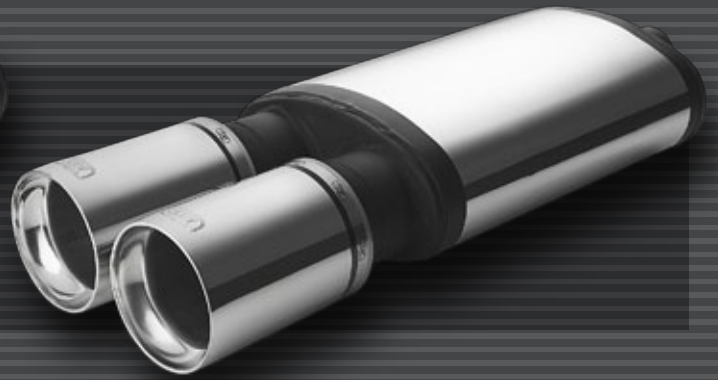

**NRS242/16** (2xØ100)  
**NM-242/16**

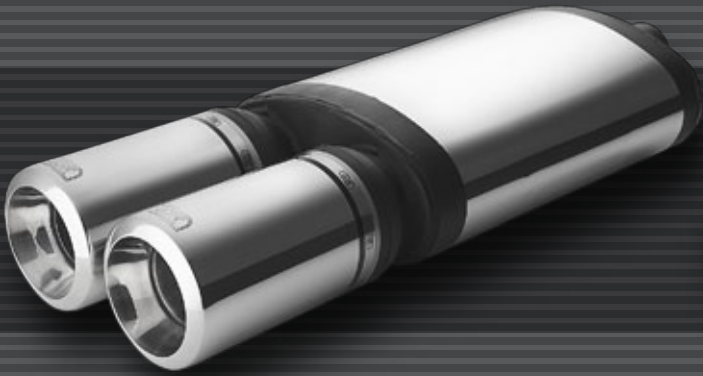

**NRS242/17-1** (2xØ100)  
**NM-242/17-1**

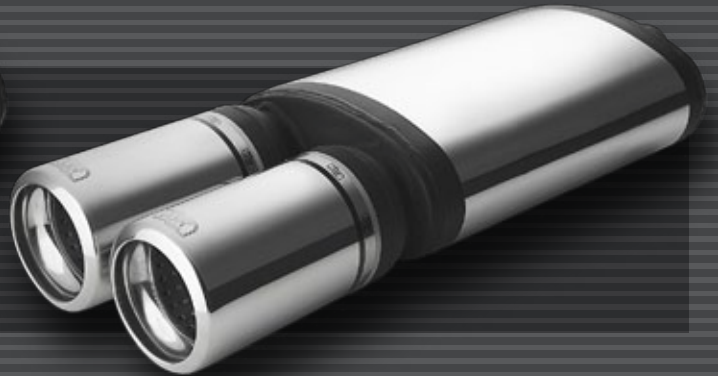

**NRS242/17-2** (2xØ100)  
**NM-242/17-2**

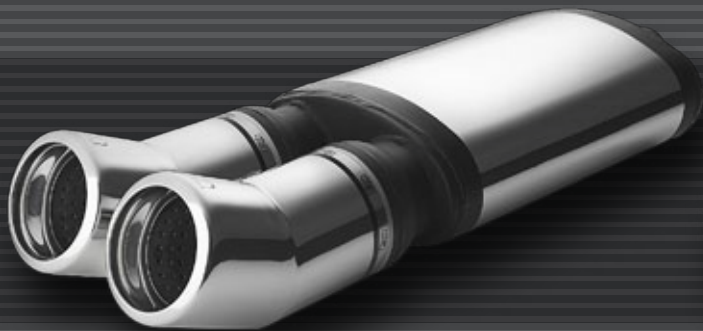

**NRS242/19-1** (2xØ100)  
**NM-242/19-1**

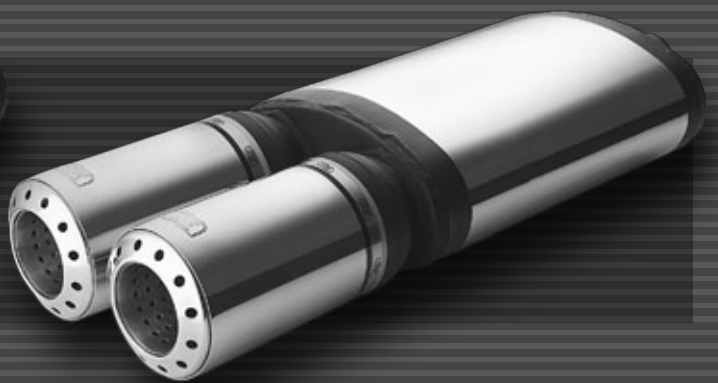

**NRS242/22** (2xØ100)  
**NM-242/22**



# UNIVERSAL MUFFLERS (STAINLESS STEEL / ALUMINIUM PLATED STEEL)

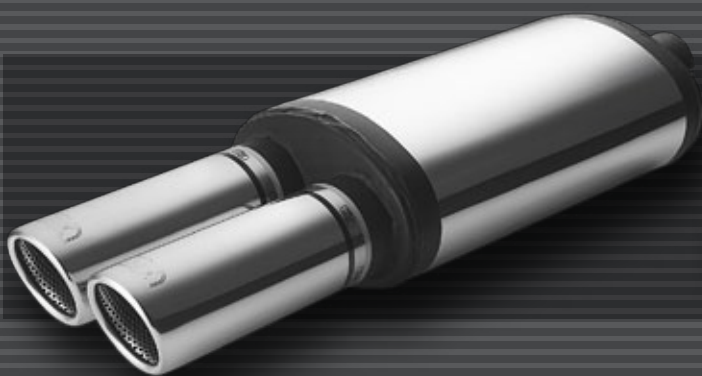

**NRS242/70RS** (2xØ70)  
**NM-242/70RS**

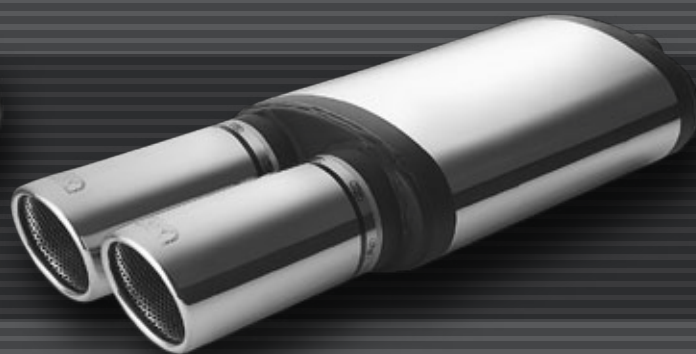

**NRS242/90RS** (2xØ90)  
**NM-242/90RS**



**NRS-001/07-1** (length 250mm, diameter 150mm)  
**NRS-002/07-1** (length 350mm, diameter 150mm)

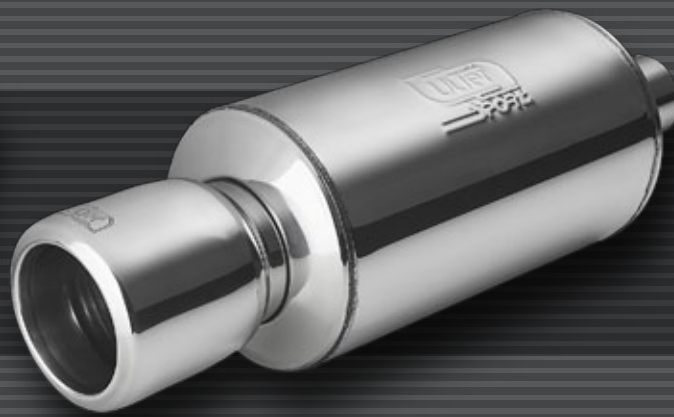

**NRS-001/16-1** (length 250mm, diameter 150mm)  
**NRS-002/16-1** (length 330mm, diameter 150mm)



**NRS-001/90RS** (length 250mm, diameter 150mm)  
**NRS-002/90RS** (length 330mm, diameter 150mm)

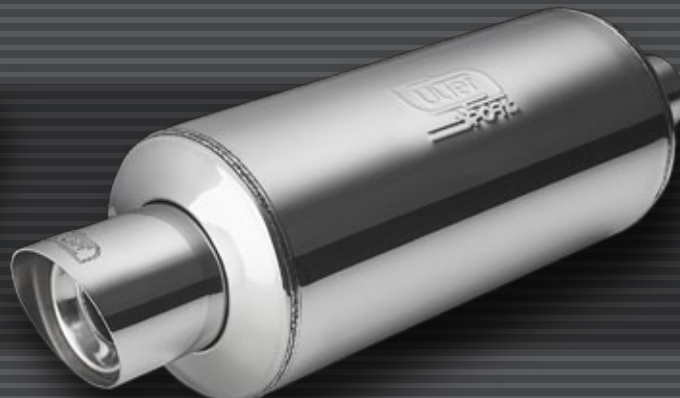

**NRS-001/08-1** (length 250mm, diameter 150mm)  
**NRS-002/08-1** (length 330mm, diameter 150mm)

# UNIVERSAL MUFFLERS (STAINLESS STEEL)

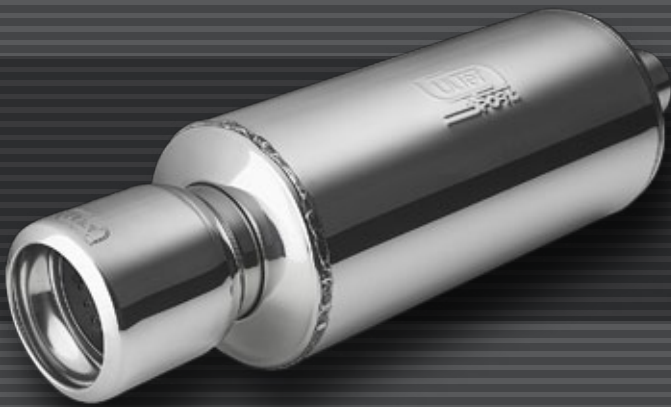

*NRS-001/17-2 (length 250mm, diameter 150mm)  
NRS-002/17-2 (length 330mm, diameter 150mm)*



*NRS-001/22-1 (length 250mm, diameter 150mm)  
NRS-002/22-1 (length 330mm, diameter 150mm)*



*NRS-003/08-1 (length 330mm, diameter 100mm)*

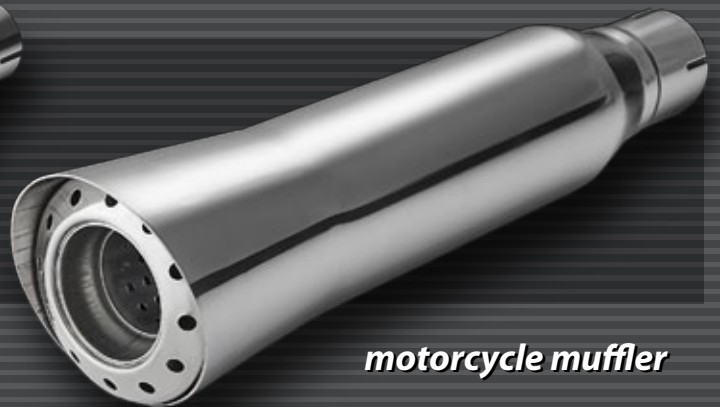

## **motorcycle muffler**

*M-01 (length 490mm)  
Universal muffler with a silencer*



## **side pipe exhaust** (Ø80mm tip; Ø60mm inlet)

*COBRA K (length max. 1100mm)  
COBRA (length max. 1400mm)  
COBRA D (length up to 1800mm)*



UlterSportRallyTeam



Wojciech Chuchata  
Sebastian Rozwadowski



ADAC OPEL RALLYE CUP

J.Tomaszczyk / E.Wtoch



ADAC OPEL RALLYE CUP

J.Tomaszczyk  
E.Wtoch



ADAC OPEL RALLYE CUP

Jerzy Tomaszczyk  
Eukasz Wtoch

OPEL ADAM



Wojciech Chuchata  
Sebastian Rozwadowski

FORD FIESTA RS



RSMP 2014 PZM

Jerzy Tomaszczyk  
Eukasz Wtoch

FORD FIESTA RS





34-350 Węgierska Górka, ul. Wyzwolenia 24

tel. +48 33 860 49 50, fax +48 33 860 49 59

● [ultersport.eu](http://ultersport.eu)



**PROGRAM  
REGIONALNY**  
NARODOWA STRATEGIA SPÓJNOŚCI



**UNIA EUROPEJSKA**  
EUROPEJSKI FUNDUSZ  
ROZWOJU REGIONALNEGO



Projekt współfinansowany przez Unię Europejską z Europejskiego Funduszu Rozwoju Regionalnego  
w ramach Regionalnego Programu Operacyjnego Województwa Śląskiego na lata 2007-2013

# Ulter SPORT

